

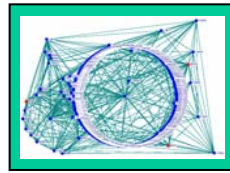

FERMILAB



Massive Metrology: Development and Implementation of a 3D Reference Frame for the Realignment of Fermilab's Tevatron

John A. Greenwood and George J. Wojcik
Alignment and Metrology Group
Particle Physics Division
Fermi National Accelerator Laboratory
Batavia, Illinois, USA

IWAA06 – SEPTEMBER 25-29, 2006

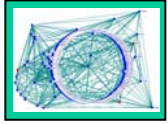

The Problem

- **The performance and reliability of the Tevatron proton and antiproton accelerator, did not meet expectations. In 2003, Tevatron Alignment Task Force (TATF) was formed by Accelerator Division to address this situation.**

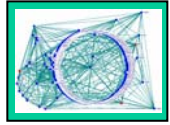

The Problem

- The performance and reliability of the Tevatron proton and antiproton accelerator, was well below expectations. In 2003, Tevatron Alignment Task Force (TATF) was formed by Accelerator Division to address this situation.
- **TATF set a timetable for the improvement of various units of the facility. As project planning developed, it became apparent that modern dimensional metrology would be a great tool for this major upgrade of the *still most powerful accelerator in the world.***

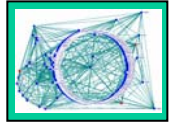

The Problem

- The performance and reliability of the Tevatron proton and antiproton accelerator, was well below expectations. In 2003, Tevatron Alignment Task Force (TATF) was formed by Accelerator Division to address this situation.
- TATF set a timetable for the improvement of various units of the facility. As project planning developed, it became apparent that modern dimensional metrology would be of great tool for this major upgrade of the *still most powerful accelerator in the world*.
- **Very important to the project was the design of the geodetic network, now known as TeVnet. The specification developed for this project stipulated the diametrically opposite points of the machine would be accurate to within 2.5mm, 1σ .**

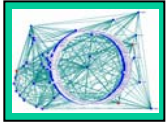

The TeVnet

TeVnet is a combined horizontal and vertical survey network which was developed to provide spatial control for the three key machines of the Fermilab accelerator complex – Tevatron, Main Injector, and Anti-Proton source. The focus of this project is on the survey network design, observation, and analysis, with the objective of increased performance and reliability of the accelerator complex, by ensuring spatially correct placement of the beam-line components.

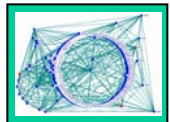

Tevatron

- **What is the Tevatron?**



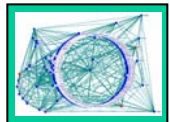

Tevatron

- **What is the Tevatron?**
- *A 6.28-km circumference, 1 Trillion electron-volt proton-antiproton accelerator which is used to study the fundamental aspects of nature.*



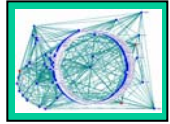

Tevatron Existing Control: the Murphy Line System

- **What is the Murphy Line System?** *The basis of the original alignment method, which has served as the magnet reference since the construction of the Tevatron.*



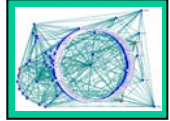

Tevatron Existing Control: the Murphy Line System

- **What is the Murphy Line System?** *The basis of the original alignment method, which has served as the magnet reference since the construction of the Tevatron.*
- *A series of 200 unconnected tangent-offset lines, inscribed by the Tevatron magnet array.*

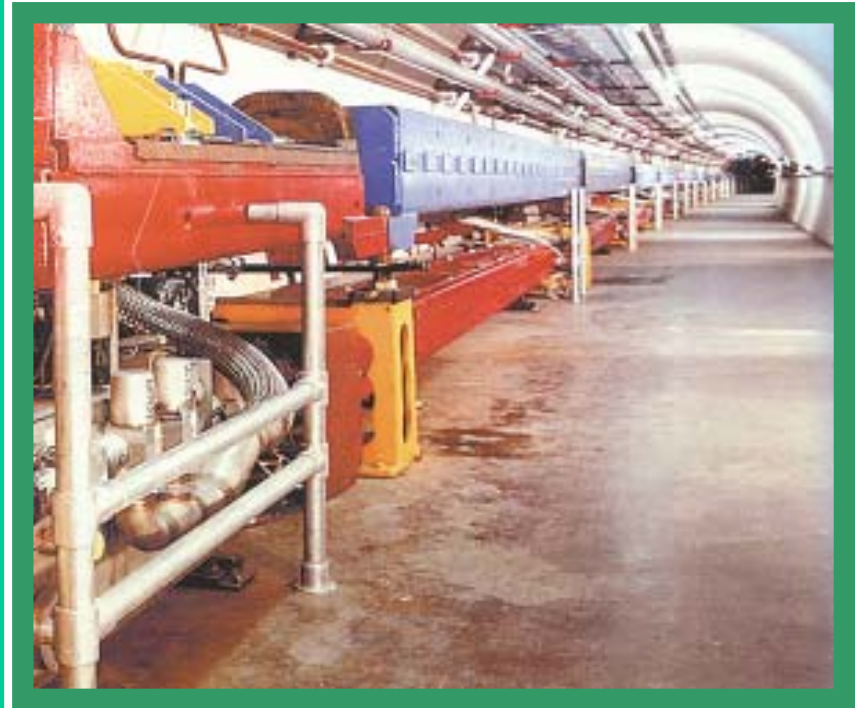

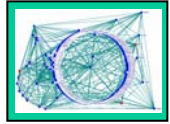

Tevatron Existing Control: the Murphy Line System

- **What's wrong with the Murphy Line System?**



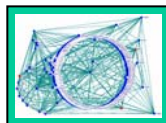

Tevatron Existing Control: the Murphy Line System

- What's wrong with Murphy lines? *Orbit shape is poorly controlled because each line constrains the alignment of only five local magnets.*

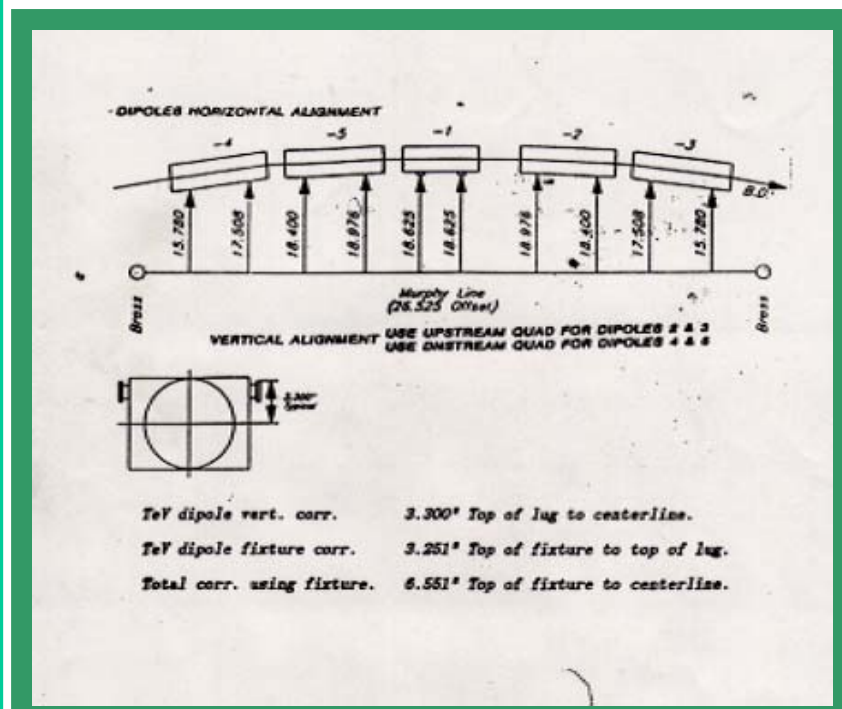

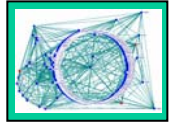

Tevatron Existing Control: the Murphy Line System

- What's wrong with Murphy lines? *Orbit shape is poorly controlled because each line constrains the alignment of only five local magnets.*
- **Murphy lines orbit?**
Orbit practically unknown.

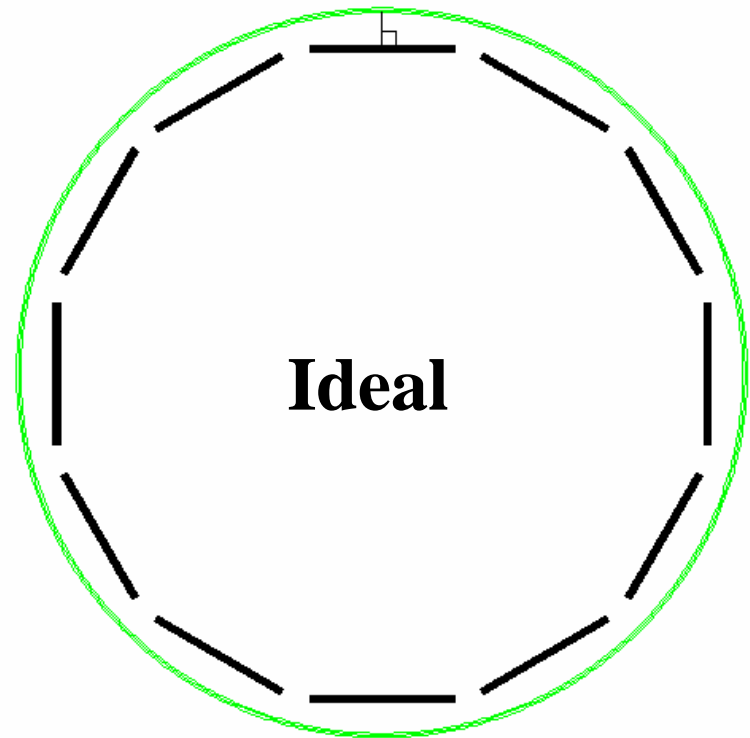

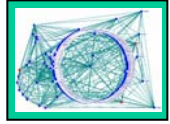

Tevatron Existing Control: the Murphy Line System

- What's wrong with Murphy lines? *Orbit shape is poorly controlled because each line constrains the alignment of only five local magnets.*
- **Murphy lines orbit?**
Orbit practically unknown

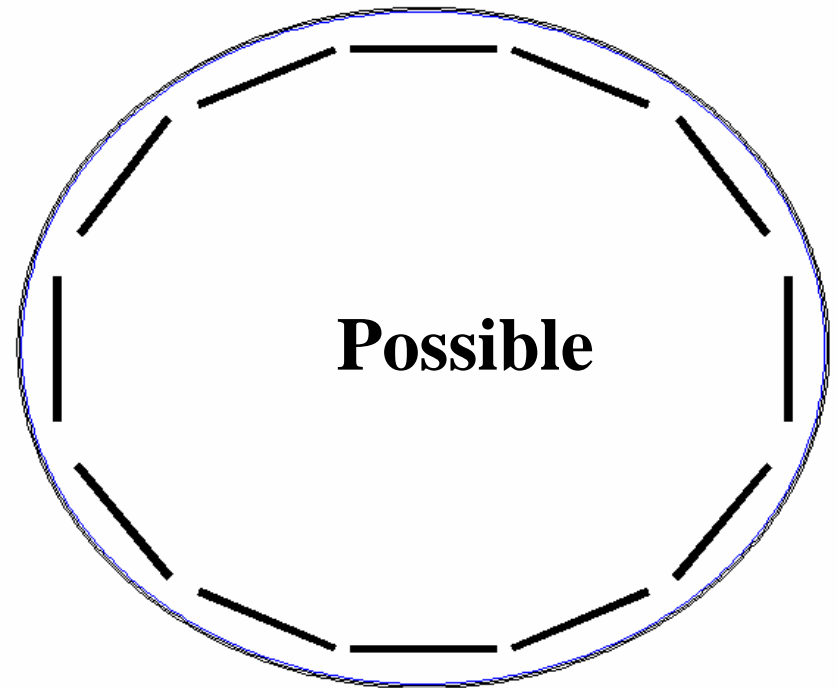

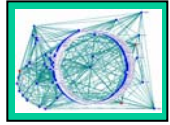

Tevatron Existing Control: the Murphy Line System

- What's wrong with Murphy lines? *Orbit shape is poorly controlled because each line constrains the alignment of only five local magnets.*
- **Murphy lines orbit?**
Orbit practically unknown

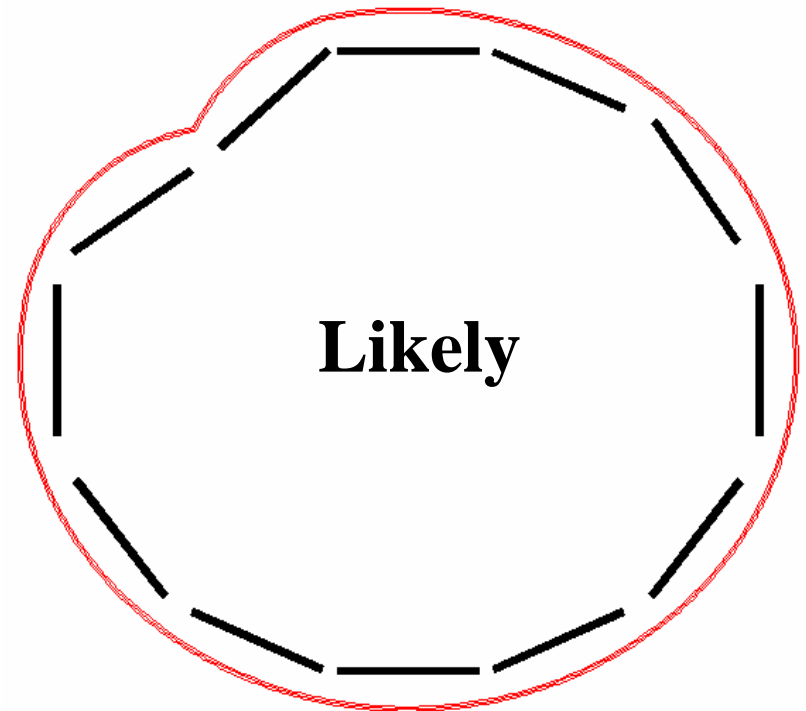



Murphy Line System evaluation

- **Survey the Murphy brass, thereby coordinating each of the plugs.**



Murphy Line System evaluation

- Survey the Murphy *brass*, thereby coordinating each of the plugs.
- **1ST Requested method:**
Holding the site coordinate system origin fixed, traverse around the ring and tie in each Murphy plug. Desired accuracy < 2.5-mm (1σ)

Traverse error ellipses,
fixed at A0

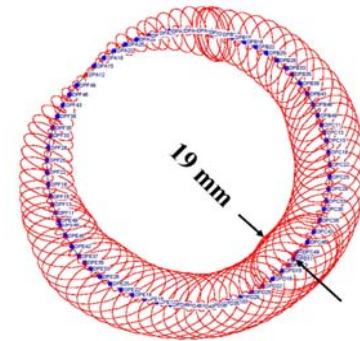
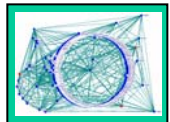
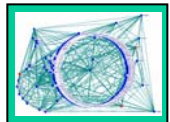

Figure 1



Development of surface network

- Survey the Murphy *brass*, thereby coordinating each of the plugs.
- **2ND Requested method:**
Open sight-risers at two available locations
- *Murphy plug. Desired accuracy < 2.5-mm (1 σ)*
- **Holding the site coordinate at two available Sight-risers at F0 and C0, located at service building at diametrically opposite sides of the ring, did not significantly improve the results of the preanalysis**



Development of surface network

- Survey the Murphy *brass*, thereby coordinating each of the plugs.
- **3rd Requested method:**
Open sight-risers at two available locations
- *Add sight-risers every ~250 meters!*
- *Murphy plug. Desired accuracy < 2.5-mm (1σ)*

- Requested for additional 22 sight-risers(every 250m)
- Quick budget estimate indicate a price of **\$10-15k** each. **\$\$\$\$ Yikes!!!**
- A search of old plans found a series of abandoned vent shafts that could be used as compromise sight-risers at 500m spacing, giving a total useful array of fourteen



Development of surface network

- Survey the Murphy *brass*, thereby coordinating each of the plugs.
- **Compromise:**
Implement 12 new sight risers (~ 500 meters), plus opening two existing sight risers

Traverse error ellipses,
constrained by surface network

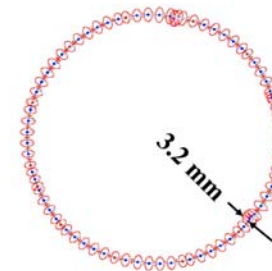
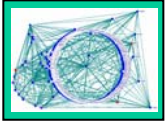
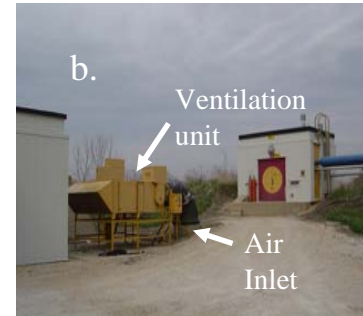
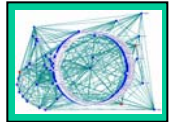

Figure 2



Sight-risers





Sight-risers location

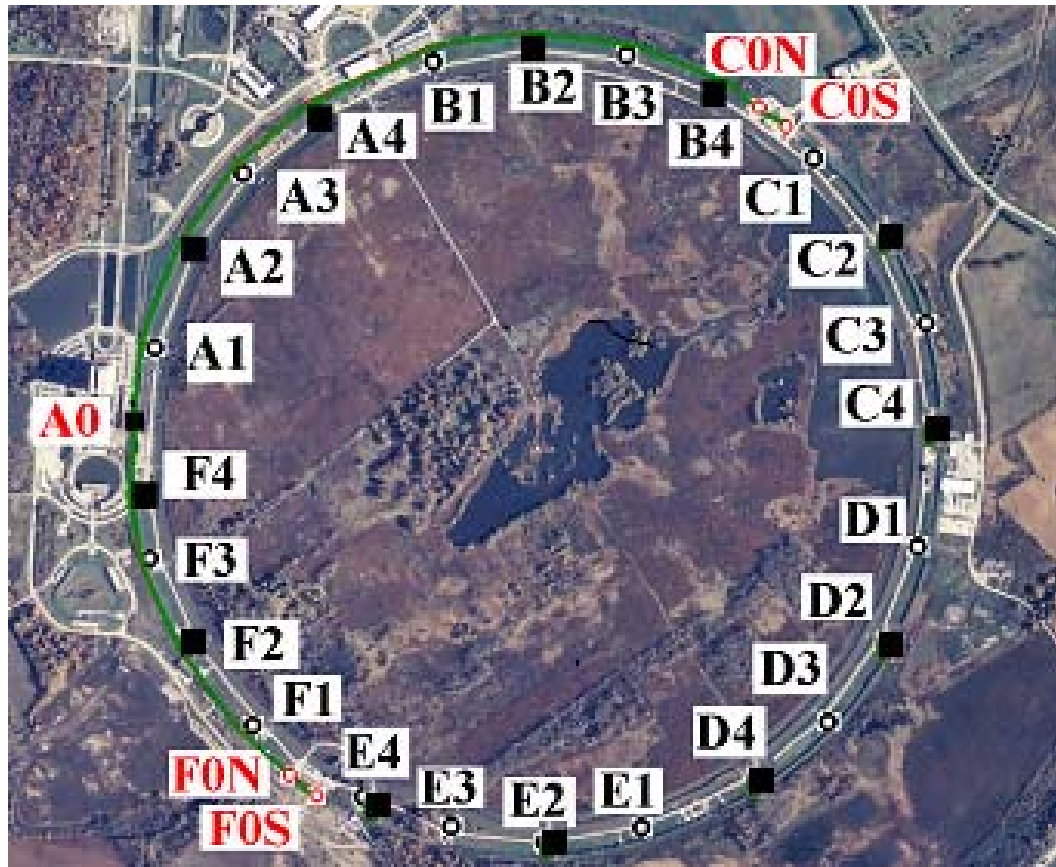

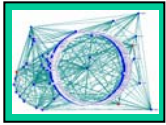

TeVnet Surface network plan

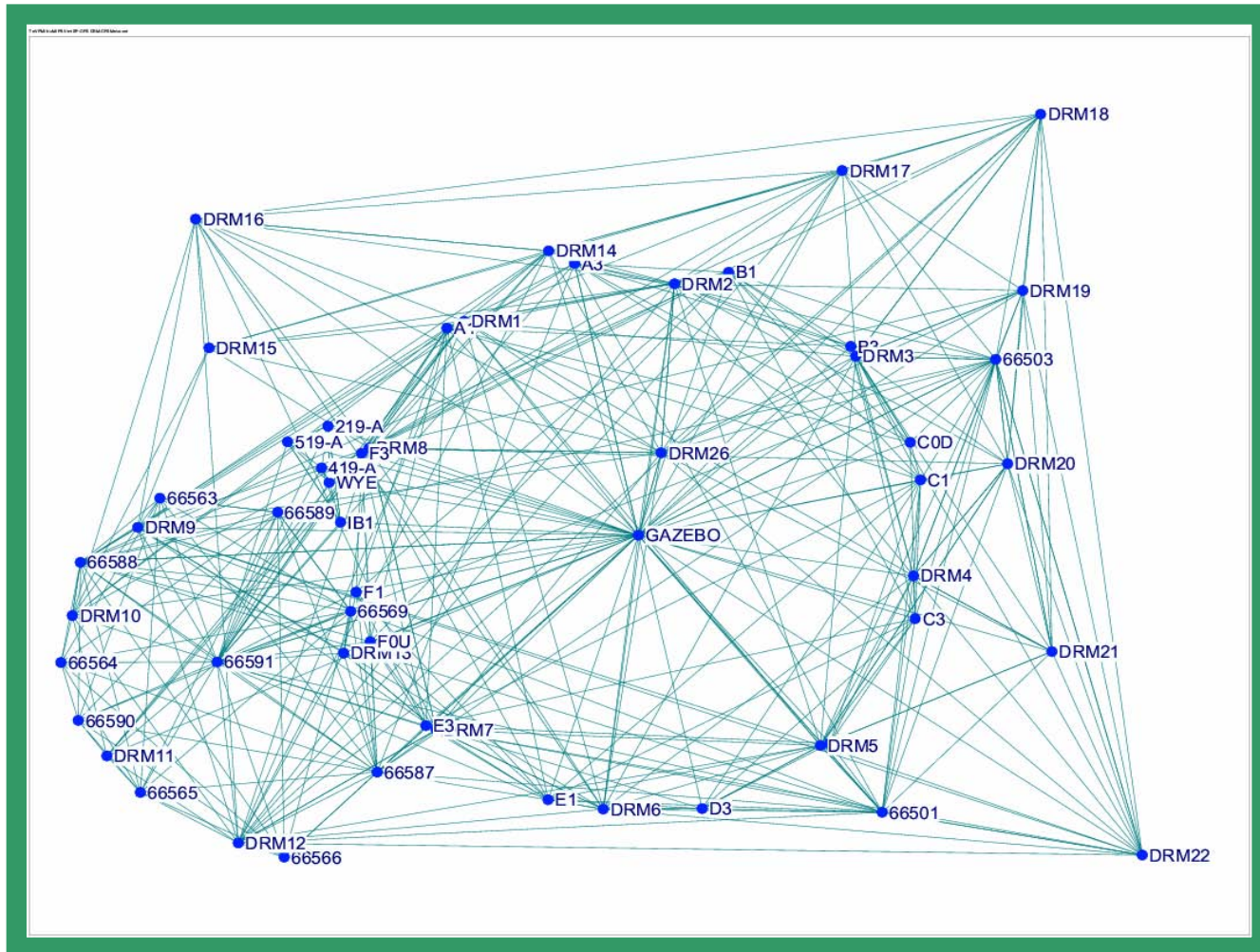

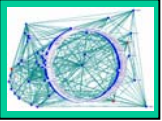

Conclusion: Murphy Line evaluation

- *Compromise: A useful array of fourteen sight-risers can be developed with a spacing of ~500m. This yields uniform error ellipses of 3.2mm. This is a significant improvement, but does not meet the desired accuracy of < 2.5mm*
- **What to do?** *Add LaserTracker tunnel network using LT in network mode.*

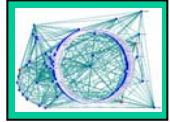

Tevatron tunnel Laser Tracker network pre-analysis

A pre-analysis of a precise Tevatron tunnel network was prepared based on using Laser Tracker observations, which would be constrained by previously described surface and tunnel networks.

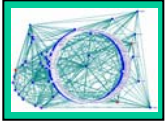

Tevatron tunnel Laser Tracker network pre-analysis

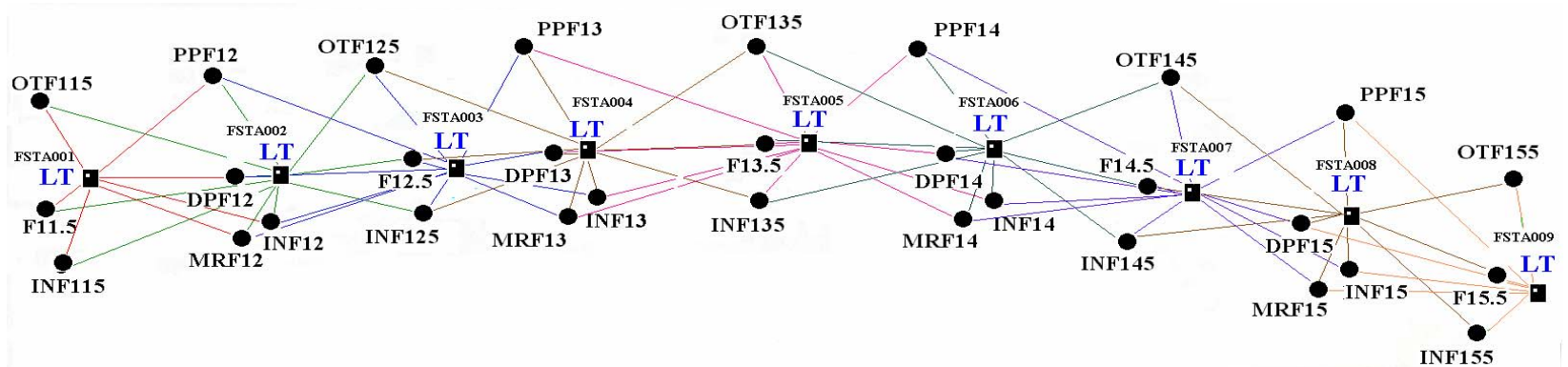
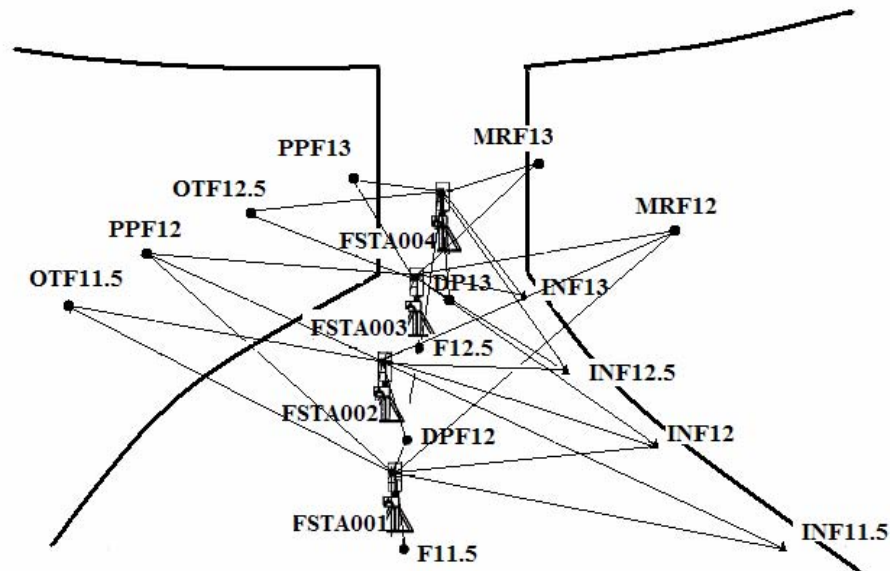

Tevatron tunnel Laser Tracker network pre-analysis

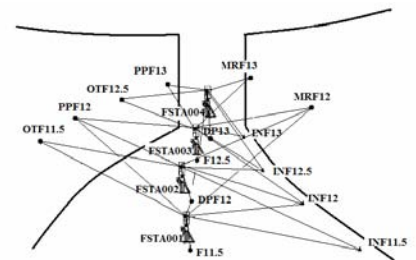
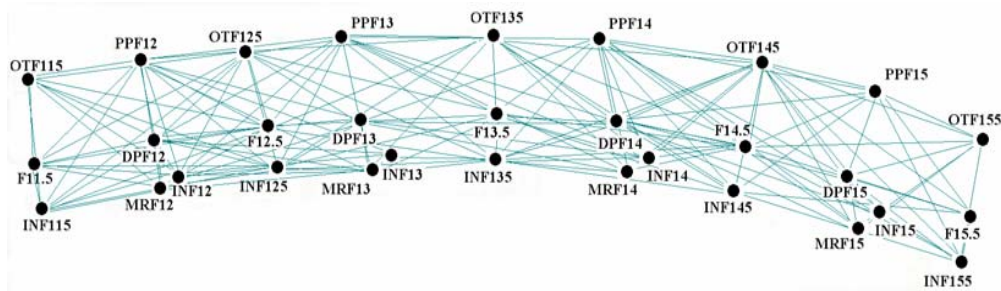
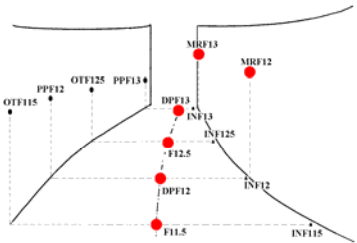
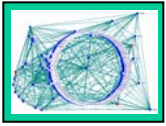

- Points surveyed using the Laser Tracker are not measured in a gravity-based system. Measurements are introduced to global preanalysis and adjustment set as follows:
- The Laser Tracker head coordinates were converted to pseudo-observations as weighted slope distances. The slope distances were calculated from three or more stations with weights being calculated according to the factory specification of the Laser Tracker, which has been validated by experience in previous surveys, such as the Main Injector and P-bar networks.
 - Pseudo observations were evaluated to remove gross errors by comparing redundant distances from different Laser Tracker stations with a rejection criteria based on the standard deviation of the observations.

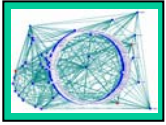

Tevatron tunnel Laser Tracker network pre-analysis

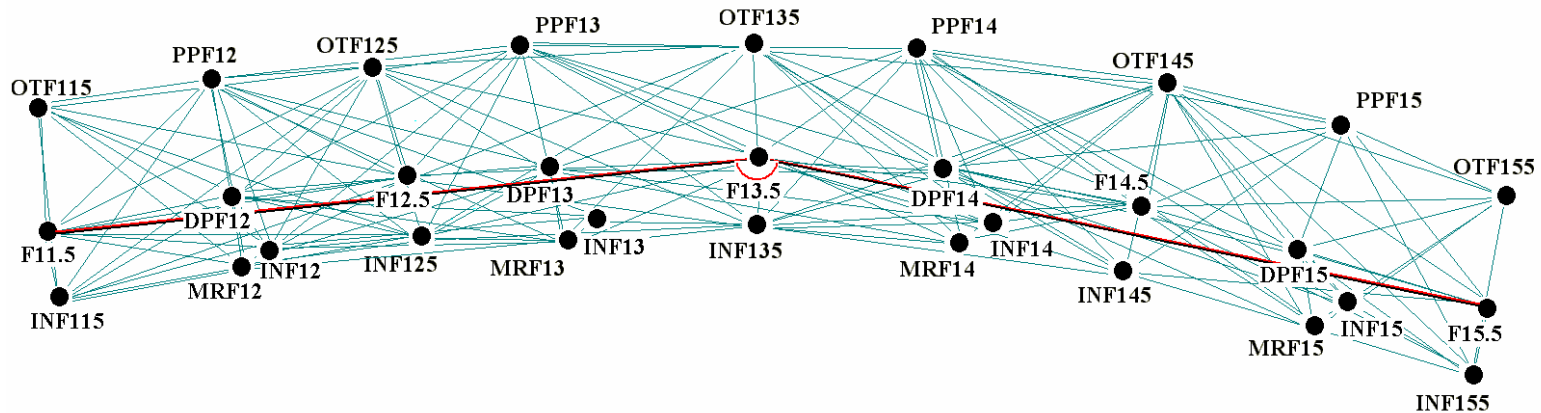
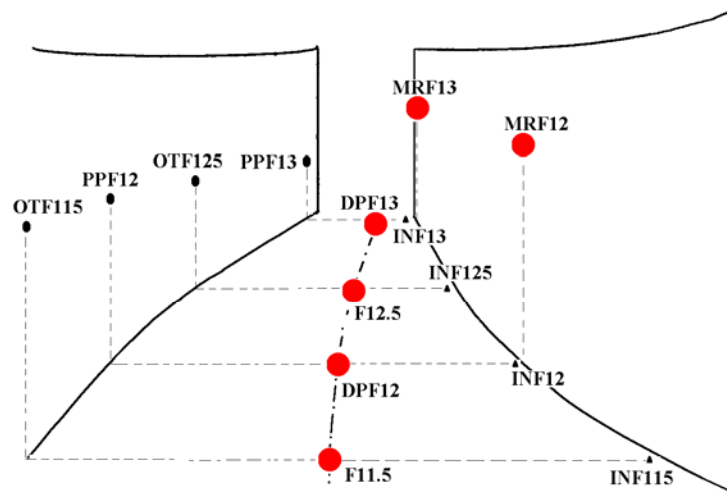



Full Network pre-analysis

**Final pre-analysis of a
underground network
Laser Tracker
observations constrained
by previously described
surface and tunnel
networks.**

***Desired accuracy < 2.5-
mm (1σ)***

LaserTracker error ellipses,
constrained by surface network

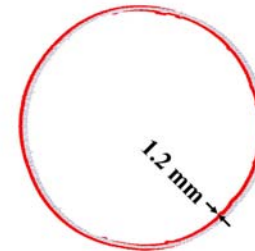
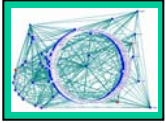
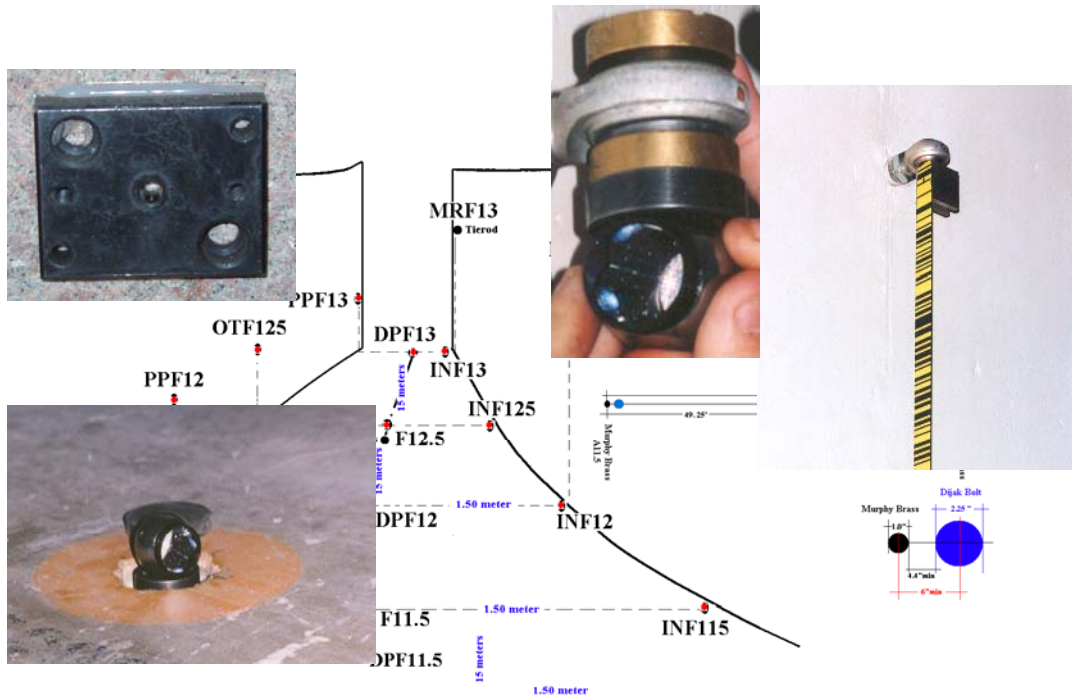

Figure 3



Field Survey Monumentation



Field Survey Instrumentation

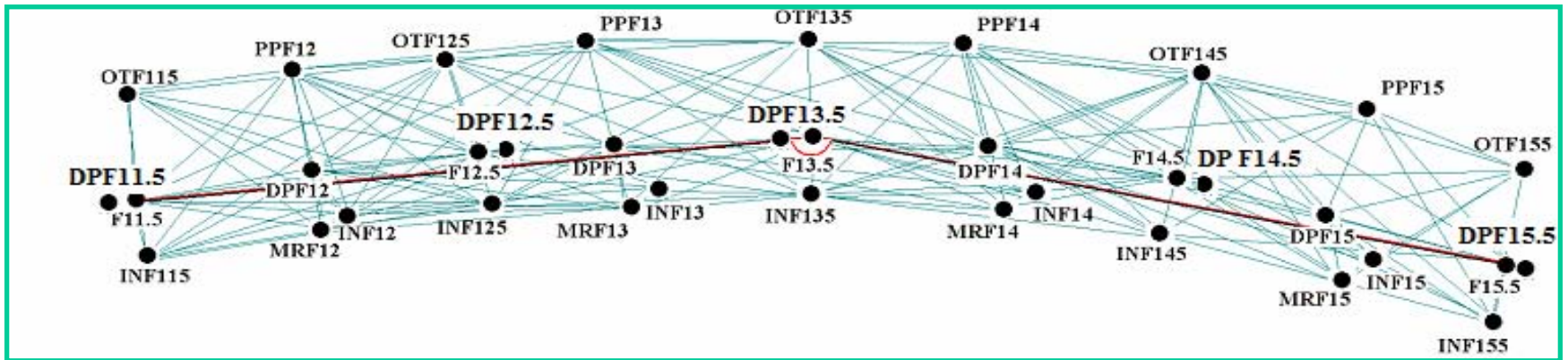

The survey of TeVnet control network was accomplished through a combination of measuring procedures utilizing the SMX Laser Tracker, Kern ME5000, Geodimeter 640 with AutoLock, Leica DNA03 digital level, Trimble 4000SSE and 5700 with Zephyr Geodetic antenna, and DMT Gyrotheodolite.

SMX Laser Tracker

KernME5000

Geodimeter 640

Leica DNA03

Trimble 4000SSE and 5700

DMT Gyrotheodolite

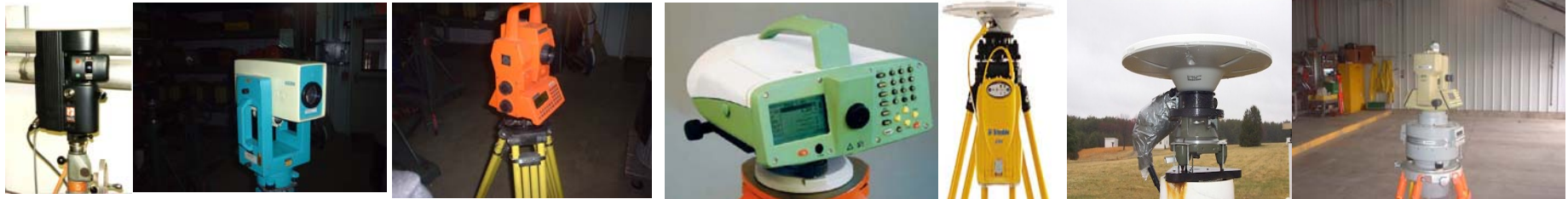

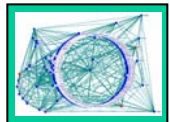

Effort

- **7 staff-months planning**
- **550 FTE-weeks fieldwork – '03+'04**
- **20 staff-months analyzing 2003 data**
- **16 staff-months analyzing 2004 data**

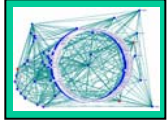

Body of Work

- **482 Tracker setups**
- **69,658 Tracker obs**
- **29,498 Tracker chords**
- **623 GPS baselines**
- **141 Mekometer obs**
- **24 Gyro-azimuth obs**
- **84 Autolock angles**
- **14 vertical drops**
- **1035 Tunnel elevs**
- **86 Surface elevs**
- **1940 coordinated pts**

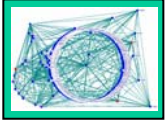

TeVnet Control Diagram

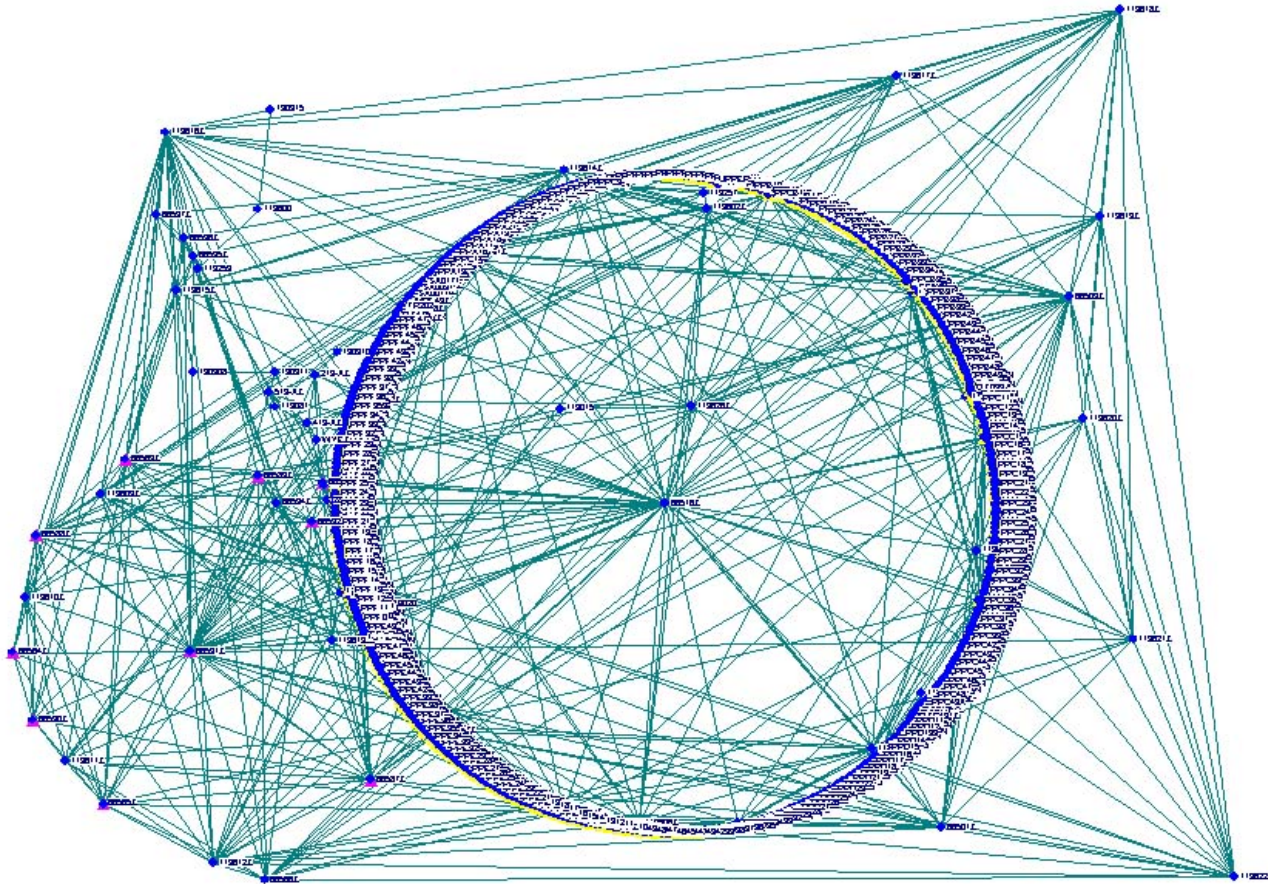

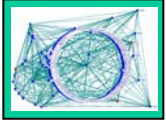

Tevatron Quads Laser Tracker Observation of Points



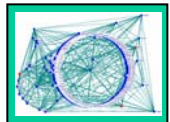

Adjustment Results

- **Constrained on 10 primary site pts and local master BM**
- **Observations: 30,403**
- **DOF: 23,308**
- **Outliers: 145**
- **Rejections: 11**

Global accuracy

- **$X_{2\sigma} = 0.65\text{mm}$**
- **$Y_{2\sigma} = 0.63\text{mm}$**
- **$Z_{2\sigma} = 0.63\text{mm}$**

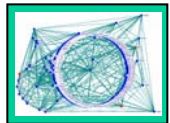

Adjustment Results

Distribution of TeVnet residuals with fit to Gaussian curve

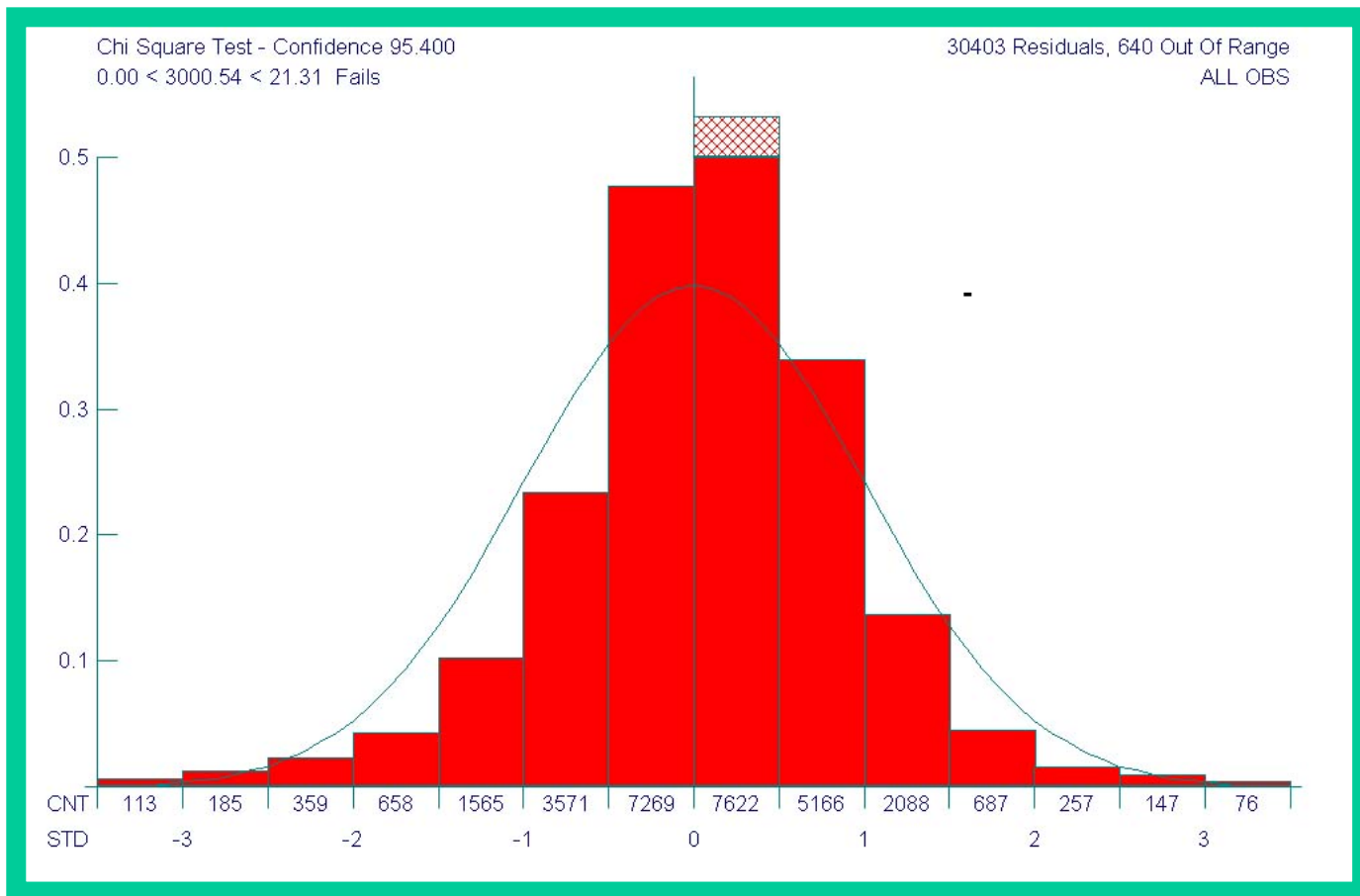

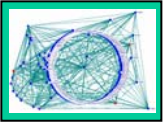

Laser tracker observations file after transformation to TeVnet coordinates system

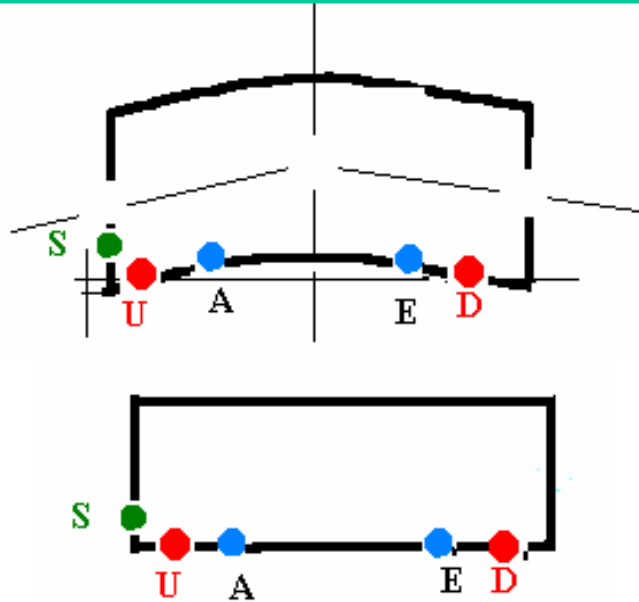

LEGEND

S = STATION

U = UPST. HORZ.

A = UPST. VERT. LUG

E = DNST. VERT. LUG

D = DNST. HORZ.

A125	3 0483.366138	30557.916426	220.296978
A135	30485.934577	30587.531035	220.293645
A12D4A	30483.104150	30559.433860	220.561880
A12D4E	30483.356280	30562.821010	220.561630
A12D4U	30483.086780	30559.331840	220.493300
A12D4D	30483.354360	30562.928680	220.492320
A12D4S	30482.816970	30558.167250	220.501730
A12D5A	30483.592620	30565.818340	220.560990
A12D5E	30483.872390	30569.207880	220.561080
A12D5U	30483.573770	30565.720040	220.497210
A12D5D	30483.870080	30569.314610	220.491240
A12D5S	30483.693180	30564.521720	220.513110
A13Q1A	30484.081470	30571.531620	220.561160
A13Q1E	30484.162720	30572.456870	220.561710
A13Q1U	30484.063830	30571.434780	220.486480
A13Q1D	30484.161470	30572.560320	220.491670
A13Q1S	30483.906040	30571.216690	220.658630
A13D2A	30484.490420	30576.327030	220.561770
A13D2E	30484.795680	30579.710950	220.560430
A13D2U	30484.471430	30576.222590	220.495800
A13D2D	30484.795590	30579.814760	220.490570
A13D2S	30484.338290	30575.048760	220.493210
A13D3A	30485.078580	30582.694780	220.560130
A13D3E	30485.413940	30586.078770	220.560520
A13D3U	30485.058300	30582.589360	220.495660
A13D3D	30485.414050	30586.178530	220.489850
A13D3S	30485.178540	30581.394930	220.539450

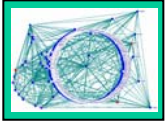

Position of Components X, Y, H, 3 Rotation Angles, Station and Length of Components from Laser Tracker Observations.

SERIAL		X	Y	H	ROLL	PITCH	YAW	STA.	LENGTH
A11Q1	UP	30480.778395	30512.806335	220.490869					
H9007	CT	30480.802077	30513.904632	220.491015	0.3800	0.1321	0.0092	34.113	2.20
	DN	30480.825758	30515.002929	220.491160					
A11D2	UP	30480.849453	30516.708273	220.491308					
TB0689	CT	30480.919674	30519.691959	220.491167	0.5600	-0.0471	3.9388	39.902	5.97
	DN	30481.001575	30522.675347	220.491027					

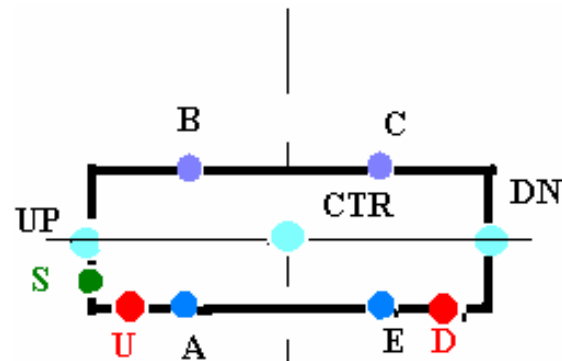
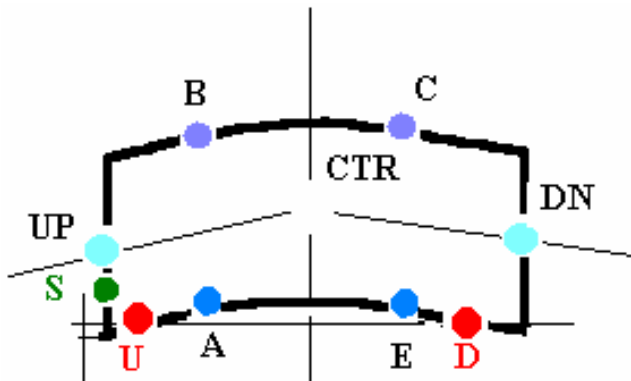

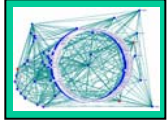

As Found Positions of Murphy Brass

As found position of the Murphy Plugs relative to ideal position

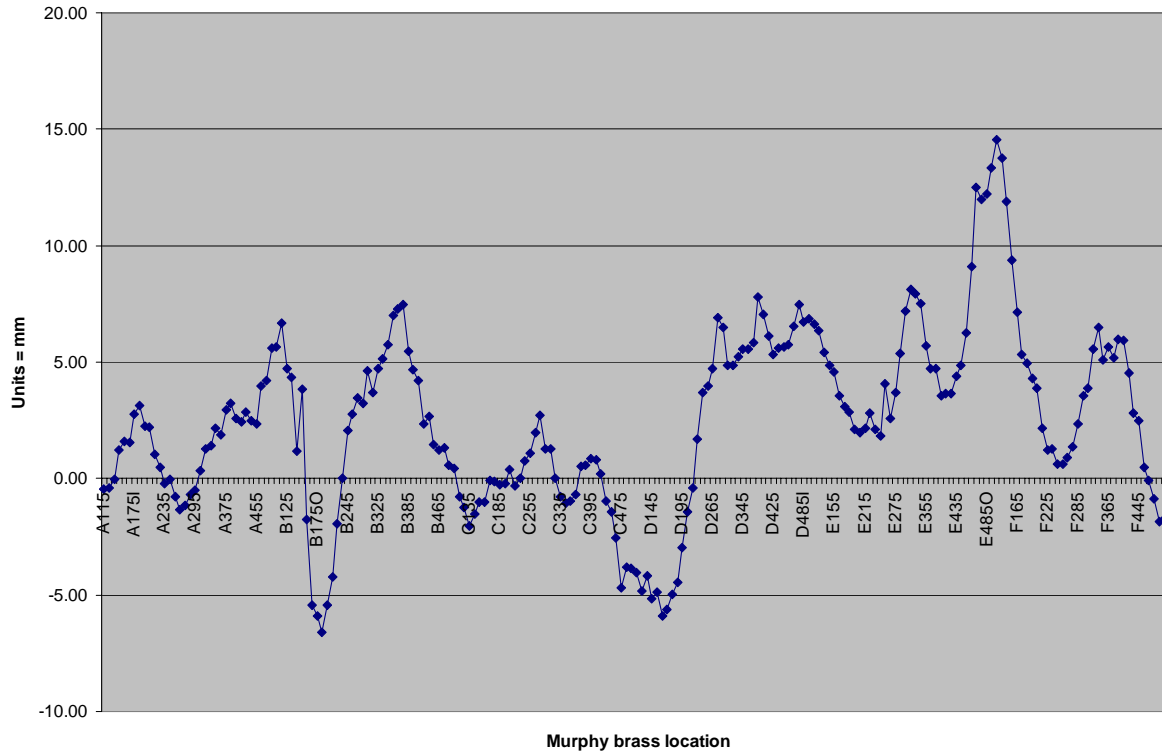

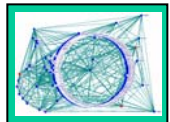

So far...

- **During the initial survey a number of obvious problems were identified and corrected.**
- **Result of TATF effort: Peak luminosity and integrated luminosity have both more than quadrupled.**

Luminosity improvement

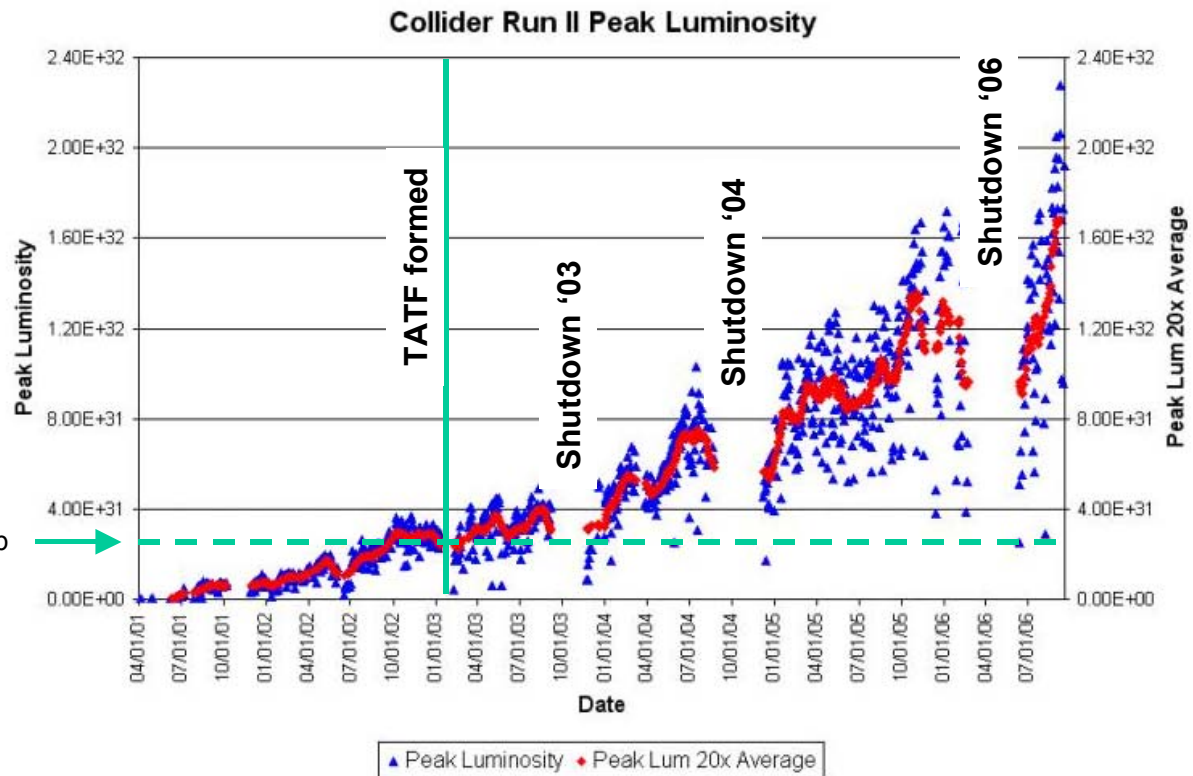

Luminosity at end of Run 1b

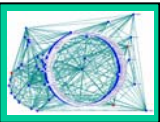

Luminosity improvement

Integrated luminosity for the last four weeks reached a total of 118.1 inverse picobarns (average of CDF and DZero). During this time, the two experiments accumulated two thirds of the total luminosity collected in all of Run I, which lasted four years

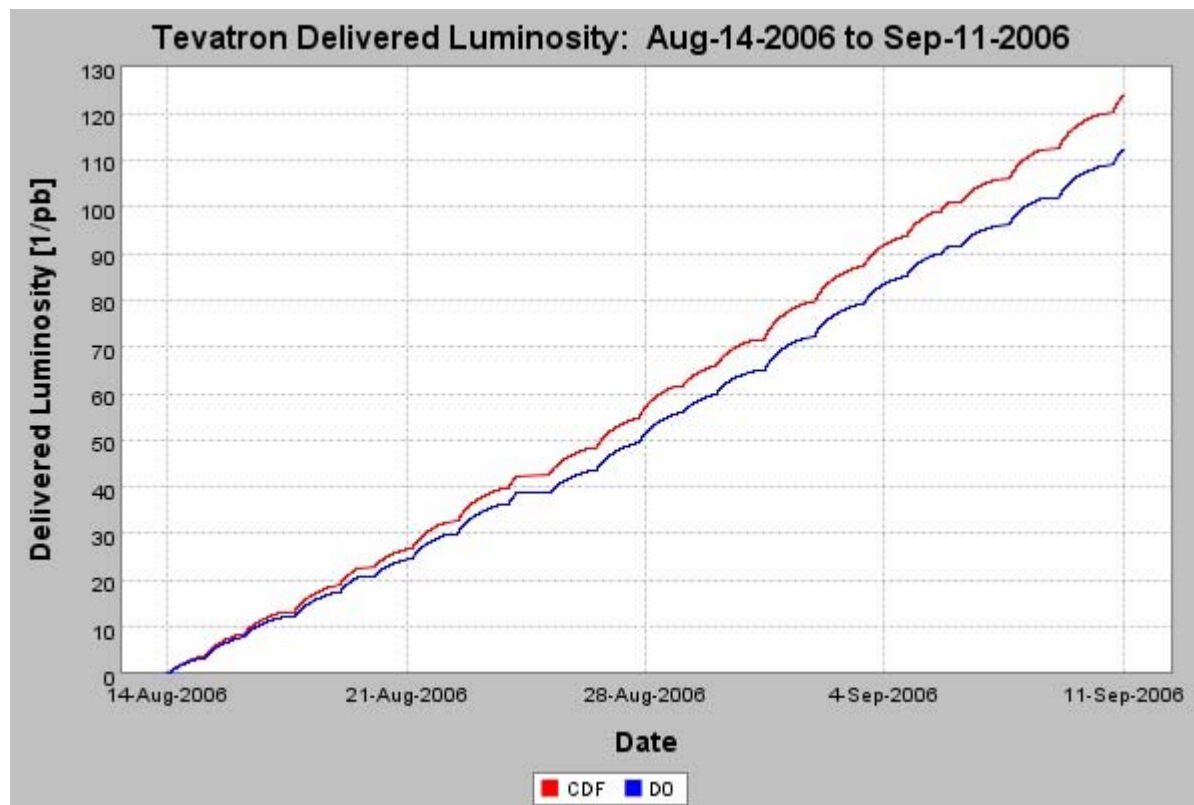

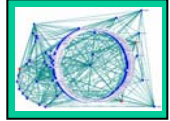

Conclusion

- **A final adjustment of the combined surface and tunnel surveys, 1940 coordinate points, was accomplished using COLUMBUS, a three-dimensional geodetic least squares adjustment program . The results of the adjustment clearly demonstrates the survey has met the requirements of the TATF.**

While not the sole source of the improvement, TeVnet made a significant contribution toward more than quadrupling the peak luminosity and integrated luminosity.

The Tevatron now produces as much data in 6 weeks as it did in all of Run I, from 1992 through 1996.

Acknowledgements

Prime mover

Terry Sager & Stu Lakanen

Impetus

Norm Gelfand, Ray Stefanski, Jim Volk
Tevatron Alignment Task Force

Counsel

Bob Bernstein

Scrutineer

Gary Coppola

GPS review

Virgil Bocean & O'Sheg Oshinowo

Heavy lifters

AMG

Glenda Adkins
Craig Bradford
Gary Crutcher

Ed Dijk

Mike O'Boyle
Charles Wilson
Jean Wilson
Randy Wyatt

ANL

Bill Jansma
Stan Johnson
Keith Knight
Scott Peterson
Scott Wesling

BNL

Terry Mroczkowski
Charles Spataro

JSS

Larry Horvath
Mike Smego

MSC

Dan Fears
Ryan McMahon
Tom Mueller
Purdy Smith
Charles Zwicker

PPD

Tony Rodriguez
Manuel Seals
Wayne Shaddix
Gary Teafoe
Jim Wish

SLAC

Cris Banuelos
Mike Rogers