

# MVME4100 Single Board Computer

Programmer's Reference

P/N: 6806800H19B

April 2009

© 2009 Emerson  
All rights reserved.

## Trademarks

Emerson, Business-Critical Continuity, Emerson Network Power and the Emerson Network Power logo are trademarks and service marks of Emerson Electric Co. © 2008 Emerson Electric Co. All other product or service names are the property of their respective owners.

Intel® is a trademark or registered trademark of Intel Corporation or its subsidiaries in the United States and other countries.

Java™ and all other Java-based marks are trademarks or registered trademarks of Sun Microsystems, Inc. in the U.S. and other countries.

Microsoft®, Windows® and Windows Me® are registered trademarks of Microsoft Corporation; and Windows XP™ is a trademark of Microsoft Corporation.

PowerPC is a trademark of IBM Corp. and used under license. FlashFX Tera™ is a trademark of Datalight, Inc..

PICMG®, CompactPCI®, AdvancedTCA™ and the PICMG, CompactPCI and AdvancedTCA logos are registered trademarks of the PCI Industrial Computer Manufacturers Group.

UNIX® is a registered trademark of The Open Group in the United States and other countries.

## Notice

While reasonable efforts have been made to assure the accuracy of this document, Emerson assumes no liability resulting from any omissions in this document, or from the use of the information obtained therein. Emerson reserves the right to revise this document and to make changes from time to time in the content hereof without obligation of Emerson to notify any person of such revision or changes.

Electronic versions of this material may be read online, downloaded for personal use, or referenced in another document as a URL to a Emerson website. The text itself may not be published commercially in print or electronic form, edited, translated, or otherwise altered without the permission of Emerson,

It is possible that this publication may contain reference to or information about Emerson products (machines and programs), programming, or services that are not available in your country. Such references or information must not be construed to mean that Emerson intends to announce such Emerson products, programming, or services in your country.

## Limited and Restricted Rights Legend

If the documentation contained herein is supplied, directly or indirectly, to the U.S. Government, the following notice shall apply unless otherwise agreed to in writing by Emerson.

Use, duplication, or disclosure by the Government is subject to restrictions as set forth in subparagraph (b)(3) of the Rights in Technical Data clause at DFARS 252.227-7013 (Nov. 1995) and of the Rights in Noncommercial Computer Software and Documentation clause at DFARS 252.227-7014 (Jun. 1995).

## Contact Address

Emerson Network Power - Embedded Computing  
2900 South Diablo Way, Suite 190  
Tempe, AZ 85282/USA

# Contents

<b>About this Manual</b> .....	<b>11</b>
<b>1 Introduction</b> .....	<b>15</b>
1.1 Overview .....	15
1.2 Features .....	15
1.3 Block Diagram .....	18
1.4 Functional Description .....	19
1.5 Programming Model .....	19
<b>2 Memory Maps</b> .....	<b>21</b>
2.1 Overview .....	21
2.1.1 Default Processor Memory Map .....	21
2.1.2 Suggested Processor Memory Map .....	21
2.1.3 PCI Memory Map .....	22
2.1.4 VME Memory Map .....	23
<b>3 Register Descriptions</b> .....	<b>25</b>
3.1 Overview .....	25
3.1.1 System Status Register .....	28
3.1.2 System Control Register .....	29
3.1.3 Status Indicator Register .....	30
3.1.4 NOR Flash Control/Status Register .....	31
3.1.5 Interrupt Register 1 .....	33
3.1.6 Interrupt Register 2 .....	34
3.1.7 Presence Detect Register .....	35
3.1.8 PCI Bus Status Registers .....	36
3.1.9 NAND Flash Chip 1 Control Register .....	38
3.1.10 NAND Flash Chip 1 Select Register .....	38
3.1.11 NAND Flash Chip 1 Presence Register .....	39
3.1.12 NAND Flash Chip 1 Status Register .....	40
3.1.13 NAND Flash Chip 2 Control Register .....	40
3.1.14 NAND Flash Chip 2 Select Register .....	41
3.1.15 NAND Flash Chip 2 Presence Register .....	42
3.1.16 NAND Flash Chip 2 Status Register .....	42

3.1.17	Watch Dog Timer Load Register	43
3.1.18	Watch Dog Control Register	43
3.1.19	Watch Dog Timer Resolution Register	44
3.1.20	Watch Dog Timer Count Register	45
3.1.21	PLD Revision Register	46
3.1.22	PLD Date Code Register	46
3.1.23	Test Register 1	47
3.1.24	Test Register 2	47
3.1.25	External Timer Registers	48
3.1.25.1	Prescaler Register	48
3.1.25.2	Control Registers	49
3.1.25.3	Compare Registers	50
3.1.25.4	Counter Register	51
3.1.26	Geographical Address Register	51
<b>4</b>	<b>Programming Details</b>	<b>53</b>
4.1	Overview	53
4.2	MPC8548E Reset Configuration	53
4.3	MPC8548E Interrupt Controller	60
4.4	Local Bus Controller Chip Select Assignments	61
4.5	I2C Device Addresses	62
4.6	User Configuration EEPROM	62
4.7	VPD EEPROM	63
4.8	RTM VPD EEPROM	63
4.9	Ethernet PHY Address	63
4.10	Flash Memory	64
4.11	PCI/PCI-X Configuration	64
4.11.1	PCI IDSEL and Interrupt Definition	65
4.11.2	PCI Arbitration Assignments	66
4.12	Other Software Considerations	66
4.12.1	MRAM	67
4.12.2	Real Time Clock	67
4.12.3	Quad UART	67
4.12.4	LBC Timing Parameters	68
4.12.5	USB Oscillator Configuration	68

4.13	Clock Distribution .....	69
4.13.1	System Clock .....	70
4.13.2	Real Time Clock Input.....	70
4.13.3	Local Bus Controller Clock Divisor .....	70
<b>A</b>	<b>Programmable Configuration Data.....</b>	<b>71</b>
A.1	Overview .....	71
A.2	List of Devices .....	71
A.3	Vital Product Data (VPD) Introduction .....	72
A.4	How to Read and Modify VPD Information .....	72
A.5	What Happens if VPD Information is Corrupted .....	72
A.6	How to Fix Corrupted VPD Information .....	73
A.7	What if Your Board Has the Wrong VPD? .....	73
A.8	How to Fix Wrong VPD Problems .....	73
A.9	Vital Product Data CRC Calculation .....	73
A.10	VPD Contents for MVME4100 Boards .....	76
<b>B</b>	<b>Related Documentation.....</b>	<b>85</b>
B.1	Emerson Network Power - Embedded Computing Documents .....	85
B.2	Manufacturers' Documents .....	85
B.3	Related Specifications .....	88



# List of Tables

Table 1-1	Board Variants	15
Table 1-2	Features List	15
Table 2-1	Default Processor Address Map	21
Table 2-2	Suggested Processor Address Map	21
Table 2-3	PCI Memory Map	22
Table 3-1	System I/O Memory Map	25
Table 3-2	System Status Register	28
Table 3-3	System Control Register	29
Table 3-4	Status Indicator Register	30
Table 3-5	NOR Flash Control/Status Register	31
Table 3-6	Interrupt Register 1	33
Table 3-7	Interrupt Register 2	34
Table 3-8	Presence Detect Register	35
Table 3-9	PCI Bus 1 Status Register	36
Table 3-10	PCI Bus 2 Status Register	36
Table 3-11	PCI Bus 3 Status Register	37
Table 3-12	NAND Flash Chip 1 Control Register	38
Table 3-13	NAND Flash Chip 1 Select Register	38
Table 3-14	NAND Flash Chip 1 Presence Register	39
Table 3-15	NAND Flash Chip 1 Status Register	40
Table 3-16	NAND Flash Chip 2 Control Register	40
Table 3-17	NAND Flash Chip 2 Select Register	41
Table 3-18	NAND Flash Chip 2 Presence Register	42
Table 3-19	NAND Flash Chip 2 Status Register	42
Table 3-20	Watch Dog Timer Load Register	43
Table 3-21	Watch Dog Timer Control Register	43
Table 3-22	Watch Dog Timer Resolution Register	44
Table 3-23	Watch Dog Timer Count Register	45
Table 3-24	PLD Revision Register	46
Table 3-25	PLD Date Code Register	46
Table 3-26	Test Register 1	47
Table 3-27	Test Register 2	47
Table 3-28	Prescaler Register	48
Table 3-29	Tick Timer Control Registers	49
Table 3-30	Tick Timer Compare Registers	50
Table 3-31	Tick Timer Counter Register	51

Table 4-1	MPC8548E POR Configuration Settings .....	54
Table 4-2	MPC8548E Interrupt Controller .....	60
Table 4-3	LBC Chip Select Assignments .....	61
Table 4-4	I2C Bus Device Addressing .....	62
Table 4-5	PHY Types and MII Management Bus Addresses .....	63
Table 4-6	NOR Flash Memory Configurations .....	64
Table 4-7	NAND Flash Memory Configurations .....	64
Table 4-8	IDSEL and Interrupt Mapping for PCI Devices .....	65
Table 4-9	Planar PCI Device Identification .....	66
Table 4-10	PCI Arbitration Assignments .....	66
Table 4-11	LBC Timing Parameters .....	68
Table 4-12	Clock Assignments .....	69
Table 4-13	Clock Frequencies .....	70
Table A-1	Programmable Devices .....	71
Table A-2	Onboard Serial EEPROMs .....	71
Table A-3	Static VPD Contents .....	76
Table A-4	Variable VPD Contents .....	83
Table B-1	Emerson Network Power - Embedded Computing Publications .....	85
Table B-2	Manufacturer's Publications .....	85
Table B-3	Related Specifications .....	88



# List of Figures

Figure 1-1	Block Diagram .....	18
Figure 3-1	Boot Flash Bank .....	32



# About this Manual

## Overview of Contents

This manual is divided into the following chapters and appendices:

*Chapter 1, Introduction*, provides a brief product description and a block diagram showing the architecture of the MVME4100 Single Board Computer.

*Chapter 2, Memory Maps*, provides information on the board's memory maps.

*Chapter 3, Register Descriptions*, contains status registers for the system resources.

*Chapter 4, Programming Details*, includes additional programming information for the board.

*Appendix A, Programmable Configuration Data*, provides additional programming information including IDSEL mapping, interrupt assignments for the MPC8548E interrupt controller, Flash memory, two-wire serial interface addressing, and other device and system considerations.

*Appendix B, Related Documentation*, provides a listing of related Emerson manuals, vendor documentation, and industry specifications.

## Abbreviations

This document uses the following abbreviations:





Acronym	Description
ASCII	American Standard Code for Information Interchange
CRC	Cyclic Redundancy Check
EEPROM	Electrically Erasable Programmable Read Only Memory
FRU	Field Replaceable Unit
Flash	Flash Memory
GB	Gigabyte
HEX	Hexadecimal
Hz	Hertz
IPMI	Intelligent Platform Management Interface

Acronym	Description
MB	Megabyte
Mfg	Manufacturing
SPD	Serial Presence Detect
VPD	Vital Product Data

## Conventions

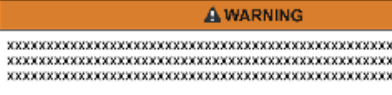
The following table describes the conventions used throughout this manual.

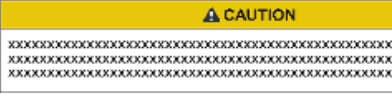
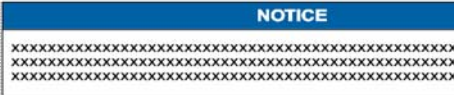
Notation	Description
0x00000000	Typical notation for hexadecimal numbers (digits are 0 through F), for example used for addresses and offsets
0b0000	Same for binary numbers (digits are 0 and 1)
<b>bold</b>	Used to emphasize a word
Screen	Used for on-screen output and code related elements or commands in body text
<b>Courier + Bold</b>	Used to characterize user input and to separate it from system output
<i>Reference</i>	Used for references and for table and figure descriptions
File > Exit	Notation for selecting a submenu
<text>	Notation for variables and keys
[text]	Notation for software buttons to click on the screen and parameter description
...	Repeated item for example node 1, node 2, ..., node 12
.	Omission of information from example/command that is not necessary at the time being
..	Ranges, for example: 0..4 means one of the integers 0,1,2,3, and 4 (used in registers)

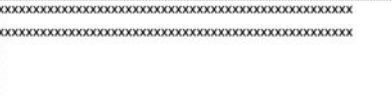
Notation	Description
	Logical OR
 	Indicates a hazardous situation which, if not avoided, could result in death or serious injury
 	Indicates a hazardous situation which, if not avoided, may result in minor or moderate injury
	Indicates a property damage message
 	No danger encountered. Pay attention to important information

## Summary of Changes

Part Number	Publication Date	Description
6806800H19A	January 2009	Early access version
6806800H19B	April 2009	Update for final release, updated "Feature List", updated the block diagram, updated "System I/O Memory Map", "System Status Register", "MPC8548E POR Configuration Settings", "MPC8548E Interrupt Controller", "I2C Bus Device Addressing", "IDSEL and Interrupt Mapping for PCI Devices", "PCI Arbitration Assignments", "LBC Timing Parameters" and "Variable VPD Contents", added information on MRAM, real time clock and Quad UART, removed "Serial Presence Detect Checksum Calculation" and "SPD Contents for MVME4100 Boards", editorial changes

## Comments and Suggestions

We welcome and appreciate your comments on our documentation. We want to know what you think about our manuals and how we can make them better.

Mail comments to us by filling out the following online form:

<http://www.emersonnetworkpowerembeddedcomputing.com/> > Contact Us > Online Form

In "Area of Interest" select "Technical Documentation". Be sure to include the title, part number, and revision of the manual and tell us how you used it.

# Introduction

## 1.1 Overview

This chapter briefly describes the board level hardware features of the MVME4100 Single Board Computer. Refer to the MPC8548E Reference Manual listed in [Appendix B, Related Documentation](#), for more detail and programming information.

At the time of publication of this manual, the MVME4100 is available in the configurations shown below.

*Table 1-1 Board Variants*

Marketing Number	Processor
MVME4100-0171	1.3 GHz MPC8548E, 4 GB NAND flash, 2 GB DDR2, Scanbe handles
MVME4100-0173	1.3 GHz MPC8548E, 4 GB NAND flash, 2 GB DDR2, IEEE handles

## 1.2 Features

Refer to the following table for a summary of the features common to all board variations.

*Table 1-2 Features List*

Function	Features
Processor / Host Controller / Memory Controller	<ul style="list-style-type: none"> <li>One MPC8548E Integrated Processor</li> <li>One e500 core with integrated L2</li> <li>Core frequency of 1.3 GHz</li> <li>One integrated four channel DMA controller</li> <li>One integrated PCI-E interface</li> <li>One integrated PCI-X interface</li> <li>Four integrated 10/100/1000 Ethernet controllers</li> <li>One integrated DUART</li> <li>Two integrated I<sup>2</sup>C controllers</li> <li>One integrated Programmable Interrupt Controller</li> <li>One integrated Local Bus Controller</li> <li>One integrated DDR2 SDRAM controller</li> </ul>

Table 1-2 Features List (continued)

Function	Features
System Memory	One DDR2 SO-CDIMM for SDRAM with ECC 2 GBytes Up to DDR533
I <sup>2</sup> C	One 8 KB VPD serial EEPROM Two 64 KB user configuration serial EEPROMs One Real Time Clock (RTC) with removable battery Dual temperature sensor One SPD for memory on SO-CDIMM Connection to XMCspan and rear transition module
Flash	128 MB soldered NOR flash with two alternate 1 MB boot sectors selectable via hardware switch H/W switch or S/W bit write protection for entire logical bank 4 GB NAND flash
NVRAM	One 512 KB MRAM extended temperature range (-40 °C to +105 °C/-40 °F to +221 °F)
PCI_E	8X Port to XMC Expansion
I/O	One front panel mini DB-9 connector for front I/O: one serial channel Two front panel RJ-45 connectors with integrated LEDs for front I/O: two 10/100/1000 Ethernet channels One front panel USB Type A upright receptacle for front I/O: one USB 2.0 channel PMC site 1 front I/O and rear P2 I/O PMC site 2 front I/O
USB	One four-channel USB 2.0 controller: one channel for front panel I/O
Ethernet	Four 10/100/1000 MPC8548E Ethernet channels: two front panel Ethernet connectors and two channels for rear P2 I/O
Serial Interface	One 16550-compatible, 9.6 to 115.2 Kbaud, MPC8548E, asynchronous serial channel: one channel for front panel I/O One quad UART (QUART) controller to provide four 16550-compatible, 9.6 to 115.2 Kbaud, asynchronous serial channels: four channels for rear P2 I/O
Timers	Four 32-bit MPC8548E timers Four 32-bit timers in a PLD



Table 1-2 Features List (continued)

Function	Features
Watchdog Timer	One watchdog timer in PLD
VME Interface	VME64 (ANSI/VITA 1-1994) compliant (3 row backplane 96-pin VME connector) VME64 Extensions (ANSI/VITA 1.1-1997) compliant (5 row backplane 160-pin VME connector) 2eSST (ANSI/VITA 1.5-2003) compliant ANSI/VITA 1.7-2003 compliant (Increased Current Level for 96 pin & 160 pin DIN/IEC Connector Standard) VITA 41.0, version 0.9 compliant Two five-row P1 and P2 backplane connectors One Tsi148 VMEbus controller
Form Factor	Standard 6U VME, one slot
Miscellaneous	One front panel RESET/ABORT switch Six front panel status indicators: <ul style="list-style-type: none"> <li>● Two 10/100/1000 Ethernet link/speed and activity (4 total)</li> <li>● Board fail</li> <li>● User S/W controlled LED</li> </ul> Planar status indicators One standard 16-pin COP header One standard 20-pin JTAG header Boundary scan support Switches for VME geographical addressing in a three-row backplane
Software Support	VxWorks OS support Linux OS support

# 1.3 Block Diagram

The following figure is a block diagram of the MVME4100 architecture.

Figure 1-1 Block Diagram

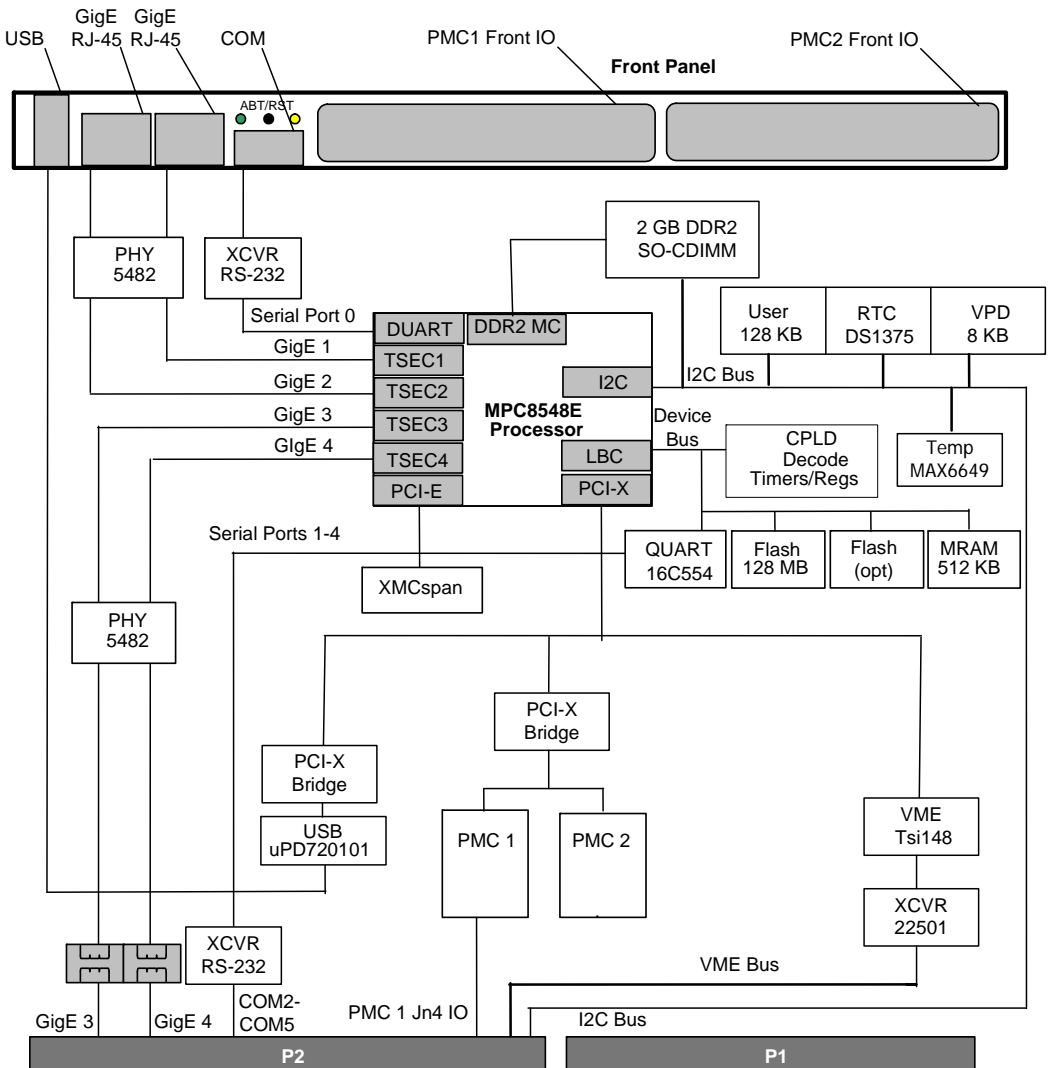

## 1.4 Functional Description

The MVME4100 VMEbus board is based on the MPC8548E system-on-chip (SoC) processor. The MVME4100 provides front panel access to one serial port with a micro DB-9 connector, two 10/100/1000 Ethernet ports with two RJ-45 connectors, and one USB port with one type A connector. The front panel includes a fail indicator LED, user-defined indicator LED, and a reset/abort switch.

The MVME7216E transition module provides rear panel access to four serial ports with one RJ-45 connector per port and two 10/100/1000 Ethernet ports with two RJ-45 connectors. The transition module also provides two planar connectors for one PIM with front I/O.

The block diagram for the MVME4100 is shown in [Figure 1-1](#) and the block diagram for the MVME7216E transition module is shown in section "Transition Module" of the *MVME4100 Single Board Computer Installation and Use* manual.

## 1.5 Programming Model

The MVME4100 programming model is based on the MPC8548E local memory map, which refers to the 32-bit address space seen by the processor as it accesses memory and I/O space. DMA engines also see the same local memory map. All memory accessed by the MPC8548E DDR2 SDRAM and local bus memory controllers exists in this memory map in addition to all memory mapped configuration, control, and status registers. Memory maps and registers are described in [Chapter 2, Memory Maps](#) and [Chapter 3, Register Descriptions](#).



# Memory Maps

## 2.1 Overview

The following sections describe the memory maps for the MVME4100. Refer to the *MPC8548E Reference Manual* for additional details and/or programming information.

### 2.1.1 Default Processor Memory Map

The following table describes a default memory map from the point of view of the processor after a processor reset.

*Table 2-1 Default Processor Address Map*

Processor Address		Size	Definition	Notes
Start	End			
0000 0000	FF6F FFFF	4087 M	Not mapped	
FF70 0000	FF7F FFFF	1 M	MPC8548E CCSR Registers	
FF80 0000	FFFF FFFF	8 M	Flash	1

1. The e500 core fetches the first instruction from FFFF FFFC following a reset.

### 2.1.2 Suggested Processor Memory Map

The following table describes a suggested physical memory map from the point of view of the processor. This table reflects the address map implemented by the board level firmware at release time.

*Table 2-2 Suggested Processor Address Map*

Processor Address		Size	Definition
Start	End		
0000 0000	top_dram - 1	dram_size (2 GB max)	System Memory (on-board DRAM)
8000 0000	CFFF FFFF	1.25 GB	PCI 0 Memory Space / VME
D000 0000	DFFF FFFF	256 MB	PCI 1 Memory Space

Table 2-2 Suggested Processor Address Map (continued)

Processor Address		Size	Definition
Start	End		
E000 0000	FFFF FFFF	256 MB	Not used
F000 0000	F07F FFFF	8 MB	PCI 0 I/O Space
F080 0000	F0FF FFFF	8 MB	PCI 1 I/O Space
F100 0000	F10F FFFF	1 MB	MPC8548E CCSR
F110 0000	F1FF FFFF	15 MB	Not used
F200 0000	F200 FFFF	64 KB	Status/Control Registers
F201 0000	F201 FFFF	64 KB	UARTs
F202 0000	F202 FFFF	64 KB	Timers
F203 0000	F203 FFFF	64 KB	NAND Flash
F204 0000	F23F FFFF	3.9 MB	Not used
F240 0000	F247 FFFF	512 KB	MRAM
F248 0000	F7FF FFFF	91.5 MB	Not used
F800 0000	FFFF FFFF	128 MB	NOR Flash

## 2.1.3 PCI Memory Map

The following table is the suggested PCI memory map for each PCI bus. This table reflects the address map implemented by the board level firmware at release time.

Table 2-3 PCI Memory Map

Processor Address		Size	Definition	Notes
Start	End			
0000 0000	top_dram - 1	dram_size	System Memory (on-board DRAM)	

## 2.1.4 VME Memory Map

The MVME4100 is fully capable of supporting both the PReP and the CHRP VME Memory Map examples with RAM size limited to 2 GB.





# Register Descriptions

## 3.1 Overview

System resources including system control and status registers, external timers, and the QUART are mapped into a 16 MB address range accessible from the MVME4100 local bus via the MPC8548E LBC. The memory map is defined in the following table including the LBC bank chip select used to decode the register.



Any address that is not listed in the table below is unused and reserved for future use.

*Table 3-1 System I/O Memory Map*

Address	Definition	LBC Bank/Chip Select	Notes
F200 0000	System Status Register	4	3
F200 0001	System Control Register	4	3
F200 0002	Status Indicator Register	4	3
F200 0003	NOR Flash Control/Status Register	4	3
F200 0004	Interrupt Register 1	4	3
F200 0005	Interrupt Register 2	4	3
F200 0006	Presence Detect Register	4	3
F200 0008	PCI Bus Status Register 1	4	3
F200 0009	PCI Bus Status Register 2	4	3
F200 000A	PCI Bus Status Register 3	4	3
F200 0010	NAND Flash Chip 1 Control Register	4	3
F200 0011	NAND Flash Chip 1 Select Register	4	3
F200 0012	Reserved	4	1
F200 0013	Reserved	4	1
F200 0014	NAND Flash Chip 1 Presence Register	4	3
F200 0015	NAND Flash Chip 1 Status Register	4	3

Table 3-1 System I/O Memory Map (continued)

Address	Definition	LBC Bank/Chip Select	Notes
F200 0016	Reserved	4	1
F200 0017	Reserved	4	1
F200 0018	NAND Flash Chip 2 Control Register	4	3
F200 0019	NAND Flash Chip 2 Select Register	4	3
F200 001A	Reserved	4	1
F200 001B	Reserved	4	1
F200 001C	NAND Flash Chip 2 Presence Register	4	3
F200 001D	NAND Flash Chip 2 Status Register	4	3
F200 001E	Reserved	4	1
F200 001F	Reserved	4	1
F200 0020	Watch Dog Timer Load	4	3
F200 0021	Reserved	4	1
F200 0022	Reserved	4	1
F200 0023	Reserved	4	1
F200 0024	Watchdog Control	4	3
F200 0025	Watchdog Resolution	4	
F200 0026 - F200 0027	Watchdog Count	4	
F200 0028	Reserved (32 bits)	4	1
F200 002C	Reserved (32 bits)	4	1
F200 0030	PLD Revision	4	3
F200 0031	Reserved	4	1
F200 0032	Reserved	4	1
F200 0033	Reserved	4	1
F200 0034	PLD Date Code (32 bits)	4	3
F200 0038	Test Register 1 (32 bits)	4	3
F200 003C	Test Register 2 (32 bits)	4	3

Table 3-1 System I/O Memory Map (continued)

Address	Definition	LBC Bank/Chip Select	Notes
F200 0018 - F200 0FFF	Reserved		1
F201 1000 - F201 1FFF	COM 2 (QUART channel 1)	5	
F201 2000 - F201 2FFF	COM 3 (QUART channel 2)	5	
F201 3000 - F201 3FFF	COM 4 (QUART channel 3)	5	
F201 4000 - F201 4FFF	COM 5 (QUART channel 4)	5	
F201 5000 - F201 FFFF	Reserved		1
F202 0000	External PLD Tick Timer Prescaler Register	6	2
F202 0010	External PLD Tick Timer 1 Control Register	6	2
F202 0014	External PLD Tick Timer 1 Compare Register	6	2
F202 0018	External PLD Tick Timer 1 Counter Register	6	2
F202 001C	Reserved	6	2
F202 0020	External PLD Tick Timer 2 Control Register	6	2
F202 0024	External PLD Tick Timer 2 Compare Register	6	2
F202 0028	External PLD Tick Timer 2 Counter Register	6	2
F202 002C	Reserved	6	2
F202 0030	External PLD Tick Timer 3 Control Register	6	2
F202 0034	External PLD Tick Timer 3 Compare Register	6	2
F202 0038	External PLD Tick Timer 3 Counter Register	6	2
F202 003C	Reserved	6	2
F202 0040	External PLD Tick Timer 4 Control Register	6	2
F202 0044	External PLD Tick Timer 4 Compare Register	6	2

Table 3-1 System I/O Memory Map (continued)

Address	Definition	LBC Bank/Chip Select	Notes
F202 0048	External PLD Tick Timer 4 Counter Register	6	2
F202 004C - F2FF FFFF	Reserved	6	1
F203 0000	NAND Chip 1 Data Register	2	3
F203 0001 - F203 0FFF	Reserved	2	1
F203 1000	NAND Chip 2 Data Register	2	3
F203 1001 - F203 FFFF	Reserved	2	1

1. Reserved for future implementation.
2. 32-bit write only.
3. Byte read/write capable.

## 3.1.1 System Status Register

The MVME4100 has a System Status Register that is a read only register used to provide general board status information.

Table 3-2 System Status Register

REG	System Status Register - 0xF200 0000							
BIT	7	6	5	4	3	2	1	0
Field	SW8	MASTER WP	PCI 66	PCI MODE	SAFE_START	RSDV	BD_TYPE	
OPER	R							
RESET	X	X	X	X	X	0	0	0

BD_TYPE	Board Type. These bits indicate the board type. 00: VME SBC 01: PrPMC 10-11: reserved
SAFE_START	ENV Safe Start. This bit reflects the current state of the ENV safe start select switch. A cleared condition indicates that the ENV settings programmed in NVRAM should be used by the firmware. A set condition indicates that firmware should use the safe ENV settings.
PCI MODE	PCI mode. This bit reflects the current state of the PCI Mode switch. A cleared condition indicates the switch is off. A set condition indicates the switch is on.
PCI 66	PCI 66. This bit reflects the current state of the PCI 66 switch. A cleared condition indicates the switch is off. A set condition indicates the switch is on.
MASTER WP	MASTER WP. This bit reflects the current state of the MASTER WP switch. A cleared condition indicates the switch is off. A set condition indicates the switch is on. When this switch is on, the NOR FLASH, NAND FLASH, MRAM and I2C EEPROMs are write protected. When this switch is off, NOR FLASH, NAND FLASH, MRAM and I2C EEPROMs are not write protected by this function. This switch does not write protect the SPD on the SO-CDIMM. Other switches and control bits may write protect individual devices.
SW8	SW8. This bit reflects the current state of SW8. A cleared condition indicates the switch is off. A set condition indicates the switch is on.

## 3.1.2 System Control Register

The MVME4100 has a System Control Register that provides general board control bits.

*Table 3-3 System Control Register*

REG	System Control Register - 0xF200 0001							
BIT	7	6	5	4	3	2	1	0
Field	BRD_RST			RSVD	RSVD	RSVD	EEPROM_ WP	RSVD
OPER	R/W			R	R	R	R/W	R
RESET	0	0	0	0	0	0	1	0

EEPROM_WP	EEPROM Write Protect. This bit is to provide protection against inadvertent writes to the on-board EEPROM devices. Clearing this bit will enable writes to the EEPROM devices. Setting this bit write protects the devices. The devices are write protected following a reset.
BRD_RST	Board Reset. These bits are used to force a hard reset of the board. If a pattern is written in bits 5-7 where bit 7 is set, bit 6 is cleared, and bit 5 is set (101), a hard reset is generated. Any other pattern written in bits 5-7, does not generate a hard reset. These bits are cleared automatically when the board reset has been completed. These bits are always cleared during a read.
RSVD	Reserved for future implementation.

### 3.1.3 Status Indicator Register

The MVME4100 provides a Status Indicator Register that may be read by the system software to determine the state of the on-board status indicator LEDs or written to by system software to illuminate the corresponding on-board LEDs.

*Table 3-4 Status Indicator Register*

REG	Status Indicator Register - 0xF200 0002							
BIT	7	6	5	4	3	2	1	0
Field	RSVD	RSVD	RSVD	RSVD	USR3	USR2	USR1 Y	USR1 R
OPER	R	R	R	R	R/W	R/W	R/W	R/W
RESET	0	0	0	0	0	0	0	1

USR1R	User LED 1 RED. This bit is used to control the USR1 bi-color LED located on the front panel. A set condition illuminates the red segment of the front panel LED and a cleared condition extinguishes the red segment of the front panel LED.
USR1Y	User LED 1 Yellow. This bit is used to control the USR1 bi-color LED located on the front panel. A set condition illuminates the yellow segment of the front panel LED and a cleared condition extinguishes the yellow segment of the front panel LED.

- USR2\_LED User LED 2. This bit is used to control the planar USR2 LED. A set condition illuminates the LED and a cleared condition extinguishes the LED.
- USR3\_LED User LED 3. This bit is used to control the planar USR3 LED. A set condition illuminates the LED and a cleared condition extinguishes the LED.
- RSVD Reserved for future implementation

### 3.1.4 NOR Flash Control/Status Register

The MVME4100 Flash Control/Status Register provides software controlled bank write protect and map select functions as well as boot block select, bank write protect, and activity status for the NOR flash.

Table 3-5 NOR Flash Control/Status Register

REG	NOR Flash Control/Status Register - 0xF200 0003							
BIT	7	6	5	4	3	2	1	0
Field	RSVD	RSVD	RSVD	MAP_SE L	F_WP_S W	F_WP_H W	FBT_BLK _SEL	FLASH_ RDY
OPER	R	R	R	R/W	R/W	R	R	R
RESET	0	0	0	0	1	X	X	1

- FLASH\_RDY Flash Ready. This bit provides the current state of the NOR flash devices Ready/Busy# pins. These open drain output pins from each flash device are wire OR'd to form Flash Ready. Refer to the appropriate flash device data sheet for a description on the function of the Ready/Busy# pin.
- FBT\_BLK\_SEL Flash Boot Block Select. This bit reflects the current state of the Boot Block B Select switch. A cleared condition indicates that boot block A is selected and mapped to the highest address. A set condition indicates that boot block B is selected and mapped to the highest address (see [Figure 3-1](#)).
- F\_WP\_HW Hardware Flash Bank Write Protect switch status. This bit reflects the current state of the FLASH BANK WP switch. A set condition indicates that the NOR Flash bank is write protected. A cleared condition indicates that the flash bank is not write protected.

F_WP_SW	Software Flash Bank Write Protect. This bit provides software-controlled protection against inadvertent writes to the flash memory devices. A set condition indicates that the entire flash is write-protected. A cleared condition indicates that the flash bank is not write-protected, only when the HW write-protect bit is not set. This bit is set during reset and must be cleared by the system software to enable writing of the flash devices.
MAP_SEL	Memory Map Select. When this bit is cleared, the flash memory map is controlled by the Flash Boot Block Select switch (see the MVME4100 Installation and Use manual for switch settings). When the Map Select bit is set, boot block A is selected and mapped to the highest address (see <a href="#">Figure 3-1</a> ).
RSVD	Reserved for future implementation.

*Figure 3-1 Boot Flash Bank*

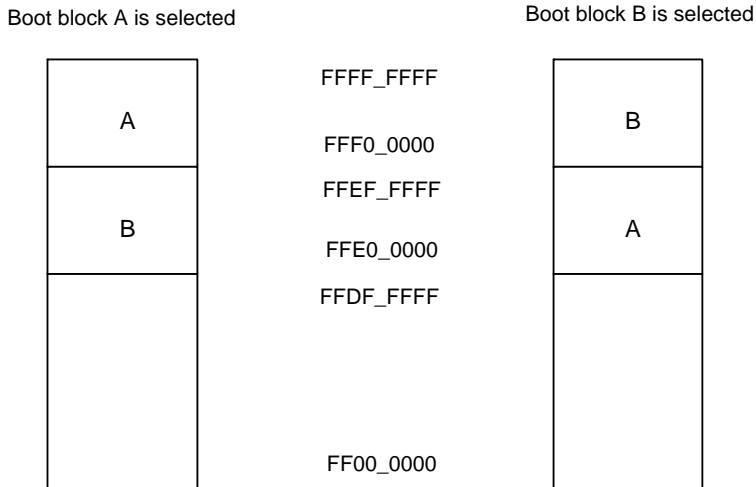



### 3.1.5 Interrupt Register 1

The MVME4100 provides an Interrupt Register that may be read by the system software to determine which of the Ethernet PHYs originated their combined (OR'd) interrupt

*Table 3-6 Interrupt Register 1*

REG	Interrupt Register 1 - 0xF200 0004							
BIT	7	6	5	4	3	2	1	0
Field	RSVD	RSVD	RSVD	RSVD	PHY4	PHY3	PHY2	PHY1
OPER	R							
RESET	0	0	0	0	0	0	0	0

- PHY1      TSEC1 PHY Interrupt. If cleared, the TSEC1 interrupt is not asserted. If set, the TSEC1 interrupt is asserted.
- PHY2      TSEC2 PHY Interrupt. If cleared, the TSEC2 interrupt is not asserted. If set, the TSEC2 interrupt is asserted.
- PHY3      TSEC3 PHY Interrupt. If cleared, the TSEC3 interrupt is not asserted. If set, the TSEC4 interrupt is asserted.
- PHY4      TSEC4 PHY Interrupt. If cleared, the TSEC4 interrupt is not asserted. If set, the FEC interrupt is asserted.
- RSVD      Reserved for future implementation.

### 3.1.6 Interrupt Register 2

The RTC, TEMP sensor and Abort switch interrupts are OR'd together. The MVME4100 provides an Interrupt Register that may be read by the system software to determine which device originated the interrupt. This register also includes bits that allow the interrupt sources to be mask.

*Table 3-7 Interrupt Register 2*

REG	Interrupt Register 2 - 0xF200 0005							
BIT	7	6	5	4	3	2	1	0
Field	RSVD	RTC Mask	TEMP Mask	ABORT Mask	RSVD	RTC Status	TEMP Status	ABORT Status
OPER	R	R/W			R			
RESET	0	1	1	1	0	X	X	0

**ABORT Status** ABORT Status. This bit reflects the current state of the on-board abort signal. This is a debounced version of the abort switch and may be used to determine the state of the abort switch. A cleared condition indicates that the abort switch is not depressed while a set condition indicates that the abort switch is asserted.

**TEMP Status** TEMP Status. If cleared, the Temperature sensor output is not asserted. If set, the Temperature sensor output is asserted.

**RTC Status** RTC Status. If cleared, the RTC output is not asserted. If set, the RTC output is asserted.

**ABORT Mask** ABORT Mask. This bit is used to mask the abort switch output. If this bit is cleared, the abort switch output is enabled to generate an interrupt. If the bit is set, the abort switch output is disabled from generating an interrupt.

**TEMP Mask** TEMP Mask. This bit is used to mask the MAX6649 temperature sensor thermostat output. If this bit is cleared, the thermostat output is enabled to generate an interrupt. If the bit is set, the thermostat output is disabled from generating an interrupt.

**RTC Mask** RTC Mask. This bit is used to mask the RTC output. If this bit is cleared, the RTC output is enabled to generate an interrupt. If the bit is set, the RTC output is disabled from generating an interrupt.

**RSVD** Reserved for future implementation.

### 3.1.7 Presence Detect Register

The MVME4100 provides a Presence Detect Register that may be read by the system software to determine the presence of optional devices.

*Table 3-8 Presence Detect Register*

REG	Presence Detect Register - 0xF200 0006							
BIT	7	6	5	4	3	2	1	0
Field	RSVD	RSVD	ERDY2	ERDY1	RSVD	XEP	PMC2P	PMC1P
OPER	R							
RESET	0	0	0	0	0	X	X	X

PMC1P	PMC Module 1 Present. If cleared, there is no PMC module installed in site 1. If set, the PMC module is installed.
PMC2P	PMC Module 2 Present. If cleared, there is no PMC module installed in site 2. If set, the PMC module is installed.
XEP	XMCspan Present. If cleared, there is no XMCspan module installed. If set, the XMCspan module is installed.
ERDY1	EREDY1. Indicates that the PrPMC module installed in PMC site 1 is ready for enumeration when set. If cleared, the PrPMC module is not ready for enumeration. If no PrPMC is installed, this bit is always set.
ERDY2	EREDY2. Indicates that the PrPMC module installed in PMC site 2 is ready for enumeration when set. If cleared, the PrPMC module is not ready for enumeration. If no PrPMC is installed, the bit is always set.
RSVD	Reserved for future implementation

### 3.1.8 PCI Bus Status Registers

The MVME4100 Status Registers provide PCI bus configuration information for each of the PCI busses.

*Table 3-9 PCI Bus 1 Status Register*

REG	PCI Bus 1 Status Register - 0xF200 0008							
BIT	7	6	5	4	3	2	1	0
Field	RSVD	RSVD	RSVD	RSVD	PCI_1_64B	PCIX_1	PCI_1_SPD	
OPER	R	R	R	R	R	R	R	R
RESET	0	0	0	0	1	X	1	0

PCI\_1\_SPD      PCI Bus 1 Speed. Indicates the frequency of PCI bus 1.  
 00: 33 MHz  
 01: 66 MHz  
 10: 100 MHz  
 11: 133 MHz

PCIX\_1      PCI-X Bus 1. A set condition indicates that bus 1 is operating in PCI-X mode. Cleared indicates PCI mode.

PCI\_1\_64B      PCI Bus 1 64-bit. A set condition indicates that bus 1 is enabled to operate in 64-bit mode. Cleared indicates 32-bit mode.

RSVD      Reserved for future implementation.

*Table 3-10 PCI Bus 2 Status Register*

REG	PCI Bus 2 Status Register - 0xF200 0009							
BIT	7	6	5	4	3	2	1	0
Field	3.3V_VIO	5.0V_VIO	RSVD	RSVD	PCI_2_64B	PCIX_2	PCI_2_SPD	
OPER	R	R	R	R	R	R	R	R
RESET	X	X	X	0	1	X	X	X

PCI_2_SPD	PCI Bus 2 Speed. Indicates the frequency of PCI bus 2. 00: 33 MHz 01: 66 MHz 10: 100 MHz 11: 133 MHz
PCIX_2	PCI-X Bus 2. A set condition indicates that bus 2 is operating in PCI-X mode. Cleared indicates PCI mode.
PCI_2_64B	PCI Bus 2 64-bit. A set condition indicates that bus 2 is enabled to operate in 64-bit mode. Cleared indicates 32-bit mode.
5.0V_VIO	5.0V VIO Enabled. This bit set indicates that the PMC bus (PCI Bus 2) is configured for 5.0V VIO.
3.3V_VIO	3.3V VIO Enabled. This bit set indicates that the PMC bus (PCI Bus 2) is configured to 3.3V VIO.

*Table 3-11 PCI Bus 3 Status Register*

REG	PCI Bus 3 Status Register - 0xF200 000A							
BIT	7	6	5	4	3	2	1	0
Field	RSVD	RSVD	RSVD	RSVD	PCI_3_64B	PCIX_3	PCI_3_SPD	
OPER	R	R	R	R	R	R	R	R
RESET	0	0	0	0	0	0	0	0

PCI_3_SPD	PCI Bus 3 Speed. Indicates the frequency of PCI bus 3. 00: 33 MHz 01: 66 MHz 10: 100 MHz 11: 133 MHz
PCIX_3	PCI-X Bus 3. A set condition indicates that bus 3 is operating in PCI-X mode. Cleared indicates PCI mode.
PCI_3_64B	PCI Bus 3 64-bit. A set condition indicates that bus 3 is enabled to operate in 64-bit mode. Cleared indicates 32-bit mode.
RSVD	Reserved for future implementation.

### 3.1.9 NAND Flash Chip 1 Control Register

The MVME4100 provides a Control Register for the NAND Flash device.

*Table 3-12 NAND Flash Chip 1 Control Register*

REG	NAND Flash Chip 1 Control Register - 0xF200 0010							
BIT	7	6	5	4	3	2	1	0
Field	CLE	ALE	WP	RSVD	RSVD	RSVD	RSVD	RSVD
OPER	R/W			R				
RESET	0	0	1	0	0	0	0	0

WP Write Protect. If cleared, WP is not asserted when the device is accessed. If set, WP is asserted when the device is accessed.

ALE Address Latch Enable. If cleared, ALE is not asserted when the device is accessed. If set, ALE is asserted when the device is accessed.

CLE Command Latch Enable. If cleared, CLE is not asserted when the device is accessed. If set, CLE is asserted when the device is accessed.

RSVD Reserved for future implementation.

### 3.1.10 NAND Flash Chip 1 Select Register

The MVME4100 provides a Select Register for the NAND Flash device.

*Table 3-13 NAND Flash Chip 1 Select Register*

REG	NAND Flash Chip 1 Select Register - 0xF200 0011							
BIT	7	6	5	4	3	2	1	0
Field	CE1	CE2	CE3	CE4	RSVD	RSVD	RSVD	RSVD
OPER	R/W				R			
RESET	0	0	0	0	0	0	0	0

- CE4 Chip Enable 4. If cleared, CE4 is not asserted when the device is accessed. If set, CE4 is asserted when the device is accessed.
- CE3 Chip Enable 3. If cleared, CE3 is not asserted when the device is accessed. If set, CE3 is asserted when the device is accessed.
- CE2 Chip Enable 2. If cleared, CE2 is not asserted when the device is accessed. If set, CE2 is asserted when the device is accessed.
- CE1 Chip Enable 1. If cleared, CE1 is not asserted when the device is accessed. If set, CE1 is asserted when the device is accessed.
- RSVD Reserved for future implementation.

### 3.1.11 NAND Flash Chip 1 Presence Register

The MVME4100 provides a Presence Register for the NAND Flash device.

*Table 3-14 NAND Flash Chip 1 Presence Register*

REG	NAND Flash Chip 1 Presence Register - 0xF200 0014							
BIT	7	6	5	4	3	2	1	0
Field	C1P	RSVD	RSVD	RSVD	RSVD	RSVD	RSVD	RSVD
OPER	R							
RESET	X	0	0	0	0	0	0	0

- C1P Chip 1 Present. If cleared, chip 1 is not installed on the board. If set, chip 1 is installed on the board.
- RSVD Reserved for future implementation.

### 3.1.12 NAND Flash Chip 1 Status Register

The MVME4100 provides a Status Register for the NAND Flash device.

*Table 3-15 NAND Flash Chip 1 Status Register*

REG	NAND Flash Chip 1 Status Register - 0xF200 0015							
BIT	7	6	5	4	3	2	1	0
Field	RB1	RB2	RB3	RB4	RSVD	RSVD	RSVD	RSVD
OPER	R							
RESET	1	1	1	1	0	0	0	0

RB4 Ready/Busy 4. If cleared, Device 4 is busy. If set, device 4 is ready.

RB3 Ready/Busy 3. If cleared, Device 3 is busy. If set, device 3 is ready.

RB2 Ready/Busy 2. If cleared, Device 2 is busy. If set, device 2 is ready.

RB1 Ready/Busy 1. If cleared, Device 1 is busy. If set, device 1 is ready.

RSVD Reserved for future implementation.

### 3.1.13 NAND Flash Chip 2 Control Register

The MVME4100 provides a Control Register for the NAND Flash device.

*Table 3-16 NAND Flash Chip 2 Control Register*

REG	NAND Flash Chip 2 Control Register - 0xF200 0018							
BIT	7	6	5	4	3	2	1	0
Field	CLE	ALE	WP	RSVD	RSVD	RSVD	RSVD	RSVD
OPER	R/W			R				
RESET	0	0	1	0	0	0	0	0



WP	Write Protect. If cleared, WP is not asserted when the device is accessed. If set, WP is asserted when the device is accessed.
ALE	Address Latch Enable. If cleared, ALE is not asserted when the device is accessed. If set, ALE is asserted when the device is accessed.
CLE	Command Latch Enable. If cleared, CLE is not asserted when the device is accessed. If set, CLE is asserted when the device is accessed.
RSVD	Reserved for future implementation.

### 3.1.14 NAND Flash Chip 2 Select Register

The MVME4100 provides a Select Register for the NAND Flash device.

*Table 3-17 NAND Flash Chip 2 Select Register*

REG	NAND Flash Chip 2 Select Register - 0xF200 0019							
BIT	7	6	5	4	3	2	1	0
Field	CE1	CE2	CE3	CE4	RSVD	RSVD	RSVD	RSVD
OPER	R/W				R			
RESET	0	0	0	0	0	0	0	0

CE4	Chip Enable 4. If cleared, CE4 is not asserted when the device is accessed. If set, CE4 is asserted when the device is accessed.
CE3	Chip Enable 3. If cleared, CE3 is not asserted when the device is accessed. If set, CE3 is asserted when the device is accessed.
CE2	Chip Enable 2. If cleared, CE2 is not asserted when the device is accessed. If set, CE2 is asserted when the device is accessed.
CE1	Chip Enable 1. If cleared, CE1 is not asserted when the device is accessed. If set, CE1 is asserted when the device is accessed.
RSVD	Reserved for future implementation.

### 3.1.15 NAND Flash Chip 2 Presence Register

The MVME4100 provides a Presence Register for the NAND Flash device.

*Table 3-18 NAND Flash Chip 2 Presence Register*

REG	NAND Flash Chip 2 Presence Register - 0xF200 001C							
BIT	7	6	5	4	3	2	1	0
Field	C2P	RSVD	RSVD	RSVD	RSVD	RSVD	RSVD	RSVD
OPER	R							
RESET	X	0	0	0	0	0	0	0

**C2P** Chip 2 Present. If cleared, chip 1 is not installed on the board. If set, chip 2 is installed on the board.

**RSVD** Reserved for future implementation.

### 3.1.16 NAND Flash Chip 2 Status Register

The MVME4100 provides a Status Register for the NAND Flash device.

*Table 3-19 NAND Flash Chip 2 Status Register*

REG	NAND Flash Chip 2 Status Register - 0xF200 001D							
BIT	7	6	5	4	3	2	1	0
Field	RB1	RB2	RB3	RB4	RSVD	RSVD	RSVD	RSVD
OPER	R							
RESET	1	1	1	1	0	0	0	0

**RB4** Ready/Busy 4. If cleared, Device 4 is busy. If set, device 4 is ready.

**RB3** Ready/Busy 3. If cleared, Device 3 is busy. If set, device 3 is ready.

**RB2** Ready/Busy 2. If cleared, Device 2 is busy. If set, device 2 is ready.

- RB1 Ready/Busy 1. If cleared, Device 1 is busy. If set, device 1 is ready.
- RSVD Reserved for future implementation.

### 3.1.17 Watch Dog Timer Load Register

The MVME4100 provides a watch dog timer load register.

*Table 3-20 Watch Dog Timer Load Register*

REG	Watch Dog Timer Control Register - 0xF200 0020							
BIT	7	6	5	4	3	2	1	0
Field	Load							
OPER	R/W							
RESET	0	0	0	0	0	0	0	0

- LOAD Counter Load. When the pattern 0xDB is written the watch dog counter will be loaded with the count value.

### 3.1.18 Watch Dog Control Register

The MVME4100 provides a watch dog timer control register.

*Table 3-21 Watch Dog Timer Control Register*

REG	Watch Dog Timer Control Register - 0xF200 0024							
BIT	7	6	5	4	3	2	1	0
Field	EN	SYS RST	RSVD	RSVD	RSVD	RSVD	RSVD	RSVD
OPER	R/W		R					
RESET	0	0	0	0	0	0	0	0

SYSRST	System Reset. If cleared a board-level reset is generated when a time-out occurs. If set, a VMEbus SYSRST is generated when a time-out occurs. If MVME4100 is SYSCON then a local reset will also result in a VMEbus SYSRST.
EN	Enable. If cleared the watch dog timer is disabled. If set the watch dog timer is enabled.
RSVD	Reserved for future implementation.

### 3.1.19 Watch Dog Timer Resolution Register

The MVME4100 provides a watch dog timer resolution register.

*Table 3-22 Watch Dog Timer Resolution Register*

REG	Watch Dog Timer Resolution Register - 0xF200 0025							
BIT	7	6	5	4	3	2	1	0
Field	RSVD	RSVD	RSVD	RSVD	RES			
OPER	R				R/W			
RESET	0	0	0	0	9			

RES	Resolution.	These bits define the resolution of the counter.
	0:	2 $\mu$ s
	1:	4 $\mu$ s
	2:	8 $\mu$ s
	3:	16 $\mu$ s
	4:	32 $\mu$ s
	5:	64 $\mu$ s
	6:	128 $\mu$ s
	7:	256 $\mu$ s
	8:	512 $\mu$ s
	9:	1 ms (default)

10:	2 ms
11:	4 ms
12:	8 ms
13:	16 ms
14:	32 ms
15:	64 ms
RSVD	Reserved for future implementation.

### 3.1.20 Watch Dog Timer Count Register

The MVME4100 provides a watch dog timer count register.

*Table 3-23 Watch Dog Timer Count Register*

REG	Watch Dog Timer Counter Register - 0xF200 0026
BIT	15:0
Field	Count
OPER	R/W
RESET	03FF

**COUNT** Count. These bits define the watch dog timer count value. When the watch dog counter is enabled or there is a write to the load register, the watch dog counter is set to the count value. When enabled the watch dog counter will decrement at a rate defined by the resolution register. The counter will continue to decrement until it reaches zero or the software writes to the load register. If the counter reaches zero a system or board-level reset will be generated.

### 3.1.21 PLD Revision Register

The MVME4100 provides a PLD revision register that can be read by the system software to determine the current revision of the timers/registers PLD.

*Table 3-24 PLD Revision Register*

REG	PLD Revision Register - 0xF200 0030							
BIT	7	6	5	4	3	2	1	0
Field	PLD_REV							
OPER	R							
RESET	01							

PLD\_REV     8-bit field containing the current timer/register PLD revision. The revision number starts with 01.

### 3.1.22 PLD Date Code Register

The MVME4100 PLD provides a 32-bit register which contains the build date code of the timers/registers PLD.

*Table 3-25 PLD Date Code Register*

REG	Date Code Register 1 - 0xF200 0034			
BIT	31:24	23:16	15:8	7:0
Field	yy	mm	dd	vv
OPER	R			
RESET	xxxx			

yy            Last two digits of year

mm           Month

dd Day  
 vv Version of the day

### 3.1.23 Test Register 1

The MVME4100 provides a 32-bit general purpose read/write register which can be used by software for PLD test or general status bit storage.

*Table 3-26 Test Register 1*

REG	Test Register 1 - 0xF200 0038
BIT	31:0
Field	TEST1
OPER	R/W
RESET	0000

TEST1 General purpose 32-bit R/W field.

### 3.1.24 Test Register 2

The MVME4100 provides a second 32-bit test register that reads back the complement of the data in Test Register 1.

*Table 3-27 Test Register 2*

REG	Test Register 2 - 0xF200 003C
BIT	31:0
Field	TEST2
OPER	R/W
RESET	FFFF

TEST2 A read from this address will return the complement of the data pattern in Test Register 1. A write to this address will write the uncomplemented data to register TEST1.

### 3.1.25 External Timer Registers

The MVME4100 provides a set of tick timer registers for access to the four external timers implemented in the timers/registers PLD. Note that these registers are 32-bit registers and are not byte writable. The following sections describe the external timer prescaler and control registers.

#### 3.1.25.1 Prescaler Register

The Prescaler Adjust value is determined by this formula:

$$\text{Prescaler Adjust} = 256 - (\text{CLKIN} / \text{CLKOUT})$$

Where CLKIN is the input clock source in MHz and CLKOUT is the desired output clock reference in MHz.

*Table 3-28 Prescaler Register*

REG	Prescaler Register - 0xF202 0000 (8 bits of a 32-bit register)							
BIT	7	6	5	4	3	2	1	0
Field	Prescaler Adjust							
OPER	R/W							
RESET	\$E7							

The prescaler provides the clock required by each of the four timers. The tick timers require a 1 MHz clock input. The input clock to the prescaler is 25 MHz. The default value is set for \$E7 which gives a 1 MHz reference clock for a 25 MHz input clock source.



### 3.1.25.2 Control Registers

Table 3-29 Tick Timer Control Registers

REG	Tick Timer 1 Control Register - 0xF202 0010 (32 bits) Tick Timer 2 Control Register - 0xF202 0020 (32 bits) Tick Timer 3 Control Register - 0xF202 0030 (32 bits) Tick Timer 4 Control Register - 0xF202 0040 (32 bits)														
BIT	31	...	11	10	9	8	7	6	5	4	3	2	1	0	
Field	R S V D	...	R S V D	I N T S	C I N T	E N T	OVF					R S V D	C O V F	C O C	E N T
OPER	R/W														
RESET	0	...	0	0	0	0	0	0	0	0	0	0	0	0	

- ENC      Enable counter. When the bit is set the counter increments  
When the bit is cleared the counter does not increment.
- COC      Clear Counter on Compare. When the bit is set the counter is reset to 0 when it compares  
with the compare register.  
When the bit is cleared the counter is not reset.
- COVF     Clear Overflow Bits. The overflow counter is cleared when a 1 is written to this bit.
- OVF      Overflow Bits. These bits are the output of the overflow counter. The overflow counter is  
incremented each time the tick timer sends an interrupt to the local bus interrupter. The  
overflow counter can be cleared by writing a 1 to the COVF bit.
- ENINT    Enable Interrupt. When the bit is set the interrupt is enabled.  
When the bit is cleared the interrupt is not enabled.
- CINT     Clear Interrupt.
- INTS     Interrupt Status.
- RSVD     Reserved for future implementation.

## 3.1.25.3 Compare Registers

The tick timer counter is compared to the Compare Register. When they are equal, the tick timer interrupt is asserted and the overflow counter is incremented. If the clear-on-compare mode is enabled the counter is also cleared. For periodic interrupts this equation should be used to calculate the compare register value for a specific period (T):

$$\text{Compare register value} = T \text{ (us)}$$

When programming the tick timer for periodic interrupts the counter should be cleared to zero by software and then enabled. If the counter does not initially start at zero, the time to the first interrupt may be longer or shorter than expected. Note that the rollover time for the counter is 71.6 minutes.

*Table 3-30 Tick Timer Compare Registers*

<b>REG</b>	Tick Timer 1 Compare Register - 0xF202 0014 (32 bits) Tick Timer 2 Compare Register - 0xF202 0024 (32 bits) Tick Timer 3 Compare Register - 0xF202 0034 (32 bits) Tick Timer 4 Compare Register - 0xF202 0044 (32 bits)		
BIT	31	...	0
Field	Tick Timer Compare Value		
OPER	R/W		
RESET	0		

### 3.1.25.4 Counter Register

When enabled the tick timer counter register increments every microsecond. software may read or write the counter at any time.

*Table 3-31 Tick Timer Counter Register*

<b>REG</b>	Tick Timer 1 Counter Register - 0xF202 0018 (32 bits) Tick Timer 2 Counter Register - 0xF202 0028 (32 bits) Tick Timer 3 Counter Register - 0xF202 0038 (32 bits) Tick Timer 4 Counter Register - 0xF202 0048 (32 bits)		
<b>BIT</b>	31	...	0
<b>Field</b>	Tick Timer Counter Value		
<b>OPER</b>	R/W		
<b>RESET</b>	0		

### 3.1.26 Geographical Address Register

The VMEbus Status Register in the Tsi148 provides the VMEbus geographical address of the MVME4100. This register reflects the inverted states of the geographical address pins at the 5-row, 160-pin P1 connector. Applications not using the 5-row backplane can use the planar switch described in the MVME4100 Installation and Use manual to assign a geographical address.



# Programming Details

## 4.1 Overview

This chapter includes additional programming information for the MVME4100. Items discussed include:

- *MPC8548E Reset Configuration on page 53*
- *MPC8548E Interrupt Controller on page 60*
- *Local Bus Controller Chip Select Assignments on page 61*
- *I2C Device Addresses on page 62*
- *User Configuration EEPROM on page 62*
- *VPD EEPROM on page 63*
- *RTM VPD EEPROM on page 63*
- *Ethernet PHY Address on page 63*
- *Flash Memory on page 64*
- *PCI/PCI-X Configuration on page 64*
- *PCI IDSEL and Interrupt Definition on page 65*
- *PCI Arbitration Assignments on page 66*
- *LBC Timing Parameters on page 68*
- *Other Software Considerations on page 66*
- *Clock Distribution on page 69*

## 4.2 MPC8548E Reset Configuration

The MVME4100 supports the power-on reset (POR) pin sampling method for processor reset configuration. The states of the various configuration pins on the processor are sampled when reset is deasserted to determine the desired operating modes. Combinations of pull-up and pull-down resistors are used to set the options. Some options are fixed and some are selectable at build time by installing appropriate pull up/pull down resistor combinations for the board's

Bill of Materials. Each option and the corresponding default setting are described in the following table. Refer to the MPC8548E reference manual, listed in [Appendix B, Related Documentation, Manufacturers' Documents on page 85](#) for additional details and/or programming information.

*Table 4-1 MPC8548E POR Configuration Settings*

MPC8548E Signal	Select Option	Default POR Setting	Description	State of Bit vs. Function	
PCI1_REQ64_L	Fixed	0	PCI1-32 Configuration	0	PCI1/PCI-X interface is 64-bit
				1	PCI1/PCI-X interface is 32-bit
PCI2_GNT3_L	Resistor	0	PCI1_CLK	0	PCI1_CLK is used as the PCI1 clock
				1	SYSClk is used as the PCI clock
PCI1_GNT1_L	Resistor	0	PCI1 interface I/O impedance	0	25 Ohm drivers
				1	42 Ohm drivers
PCI1_GNT2_L	Fixed	1	PCI arbiter configuration	0	Disable on-chip PCI/PCI-X arbiter
				1	Enable on-chip PCI/PCI-X arbiter
PCI1_GNT3_L	Fixed	1	PCI debug configuration	0	PCI debug enabled
				1	PCI operates in normal mode
PCI1_GNT4_L	PLD	0	PCI/PCI-X configuration	0	PCI-X mode
				1	PCI mode
EC_MDC	Fixed	0	TSEC 1 and 2 width configuration	0	TSEC 1 and 2 in reduced mode (RTBI or RGMII)
				1	TSEC 1 and 2 in standard mode (TBI or GMII)

Table 4-1 MPC8548E POR Configuration Settings (continued)

MPC8548E Signal	Select Option	Default POR Setting	Description	State of Bit vs. Function	
TSEC1_TXD[0], TSEC1_TXD[7]	Fixed	10	TSEC1 protocol configuration	00	TSEC1 controller uses 16-bit FIFO mode (8-bit FIFO mode if TSEC1 configured in reduced mode)
				01	TSEC1 controller uses MII protocol (RMII id TSEC1 configured in reduced mode)
				10	TSEC1 controller uses GMII protocol (RGMII if TSEC1 configured in reduced mode)
				11	TSEC1 controller uses TBI protocol (RTBI if TSEC1 configured in reduced mode)
TSEC1_TCD[6:4]	Fixed	111	Boot ROM location	000	PCI1/PCI-X
				001	DRR SDRAM
				010	PCI2
				011	Serial Rapid IO
				100	PCI Express
				101	Local bus GPCM- 8-bit ROM
				110	Local bus GPCM - 16-bit ROM
				111	Local bus GPCM - 32-bit ROM

Table 4-1 MPC8548E POR Configuration Settings (continued)

MPC8548E Signal	Select Option	Default POR Setting	Description	State of Bit vs. Function	
TSEC1_TCD[3:1]	Fixed	111	I/O port selection	000	Reserved
				001	Reserved
				010	Reserved
				011	Serial Rapid IO x4 (2.5 Gbps); PCI Express x4
				100	Serial Rapid IO x4 (1.25 Gbps); PCI Express x4
				101	Serial Rapid IO x4 (3.125 Gbps)
				110	Serial Rapid IO x4 (1.25 Gbps)
				111	PCI Express x8
TSEC2_TXD[0], TSEC2_TXD[7]	Fixed	10	TSEC2 protocol configuration	00	TSEC2 controller uses 16-bit FIFO mode (8-bit FIFO mode if TSEC2 configured in reduced mode)
				01	TSEC2 controller uses MII protocol (RMII if TSEC2 configured in reduced mode)
				10	TSEC2 controller uses GMII protocol (RGMII if TSEC2 configured in reduced mode)
				11	TSEC2 controller uses TBI protocol (RTBI if TSEC2 configured in reduced mode)
TSEC2_TXD[1], TSEC2_RX_ER]	Fixed	11	DDR DRAM type	00	Reserved
				01	DDR1
				10	Reserved
				11	DDR2



Table 4-1 MPC8548E POR Configuration Settings (continued)

MPC8548E Signal	Select Option	Default POR Setting	Description	State of Bit vs. Function	
TSEC3_TXD[0], TSEC3_TXD[1]	Fixed	10	TSEC3 protocol configuration	00	TSEC3 controller uses 16-bit FIFO mode (8-bit FIFO mode if TSEC3 configured in reduced mode)
				01	TSEC3 controller uses MII protocol (RMII if TSEC3 configured in reduced mode)
				10	TSEC3 controller uses GMII protocol (RGMII if TSEC3 configured in reduced mode)
				11	TSEC3 controller uses TBI protocol (RTBI if TSEC3 configured in reduced mode)
TSEC3_TXD[2]	Fixed	0	TSEC 3 and 4 configuration width	0	TSEC 3 and 4 in reduced mode (RTBI or RGMII)
				1	TSEC 3 and 4 in standard mode (TBI or GMII)
TSEC4_TXD[0], TSEC4_TXD[7]	Fixed	10	TSEC4 protocol configuration	00	Reserved
				01	TSEC4 controller uses RMII protocol
				10	TSEC3 controller uses RGMII protocol
				11	TSEC3 controller uses RTBI protocol
TSEC4_TXD[2]	Fixed	1	SerDes enable	0	SerDes interface is disabled
				1	SerDes interface is enabled
LA[27]	Fixed	1	CPU boot configuration	0	CPU boot hold off mode
				1	e500 core boots without waiting for configuration by an external master

Table 4-1 MPC8548E POR Configuration Settings (continued)

MPC8548E Signal	Select Option	Default POR Setting	Description	State of Bit vs. Function	
				Bit	Function
LA[28:31]	Resistors	1000 533 MHz	CCB clock PLL ratio (CBB clock:SYSCLK)	0000	16:1
				0100	2:1
				0011	3:1
				0100	4:1
				0101	5:1
				0110	6:1
				1000	8:1
				1001	9:1
				1010	10:1
				1100	12:1
1101	20:1				
LWE[0]	PLD	1	PCI1 speed	0	PCI at or below 33 MHz; PCI-X at 66 MHz
				1	PCI above 33 MHz; PCI-X above 66 MHz
LWE[1:3]_L	PLD	111	Host/agent configuration	000	Agent of RapidIO and PCI Express; host for PCI1/PCI-X
				001	Agent of a RapidIO; host PCI Express and PCI1/PCI-x
				010	Endpoint PCI Express; host RapidIO and PCI/PCI-X
				011	Reserved
				100	Agent PCI1/PCI-X and RapidIO; root complex PCI Express
				110	Agent PCI1/PCI-X; host RapidIO; root complex PCI Express
				111	Host processor/root complex

Table 4-1 MPC8548E POR Configuration Settings (continued)

MPC8548E Signal	Select Option	Default POR Setting	Description	State of Bit vs. Function	
				Bit	Function
LBCTL, LALE, LGPL2	Resistors	101	e500 core clock PLL ratio (e500 core:CCB clock)	000	4:1
				001	9:2 (4.5:1)
				010	1:1
				011	3:2 (1.5:1)
				100	2:1
				101	5:2 (2.5:1)
				110	3:1
				111	7:2 (3.5:1)
LGPL3, LGPL5	Fixed	11	Boot sequencer configuration	00	Reserved
				01	Boot sequencer enabled with normal I2C address mode
				10	Boot sequencer enabled with extended I2C address mode
				11	Boot sequencer disabled
MSRCID0	Fixed	1	Memory debug configuration	0	Debug info from the LBC is driven on MSRCID and MDVAL pins
				1	Debug info from the DDR SDRAM controller is driven on MSRCID and MDVAL pins
MSRCID1	Fixed	1	DDR debug configuration	0	Debug info on ECC pins instead of normal ECC
				1	ECC pins function in normal mode

## 4.3 MPC8548E Interrupt Controller

The MVME4100 uses the MPC8548E integrated programmable interrupt controller (PIC) to manage locally generated interrupts. Currently defined external interrupting devices and interrupt assignments, along with corresponding edge/levels and polarities, are shown in the following table.

Table 4-2 MPC8548E Interrupt Controller

Interrupt #	Edge/Level	Polarity	Interrupt Source	Notes
0	Level	Low	Tsi148 INTA	
1	Level	Low	Tsi148 INTB	
2	Level	Low	Tsi148 INTC	
3	Level	Low	Tsi148 INTD	
4	Level	Low	PMC1, PMC2, USB	
5	Level	Low	PMC1, PMC2, USB	
6	Level	Low	PMC1, PMC2, USB	
7	Level	Low	PMC1, PMC2	
8	Level	Low	XMCspan	
9	Level	Low	RTC, TEMP, Abort	
10	Level	Low	PHYs	
11	Level	Low	UARTs, External Timer	1,2

1. External timers are implemented in a PLD.
2. External UARTs are implemented using a QUART.

Refer to the *MPC8548E Reference Manual* listed in [Appendix B, Related Documentation](#), for additional details regarding the operation of the MPC8548E PIC.

## 4.4 Local Bus Controller Chip Select Assignments

The following table shows local bus controller (LBC) bank and chip select assignments for the MVME4100 board.

*Table 4-3 LBC Chip Select Assignments*

LBC Bank / Chip Select	Local Bus Function	Size	Data Bus Width	Notes
0	Boot flash bank	128 MB	32 bits	1
1	Boot flash bank	128 MB	32 bits	1
2	NAND flash bank	64 KB	8 bits	-
3	MRAM	512 KB	16 bits	4
4	Control/status registers	64 KB	32 bits	2
5	Quad UART	64 KB	8 bits	-
6	32-bit Timers	64 KB	32 bits	3
7	Not Used	-	-	-

1. Flash bank size determined by VPD flash packet.
2. Control/Status registers are byte read and write capable.
3. 32-bit timer registers are byte readable, but must be written as 32 bits.
4. MRAM is byte read and write capable.

## 4.5 I<sup>2</sup>C Device Addresses

A two-wire serial interface is provided by an I<sup>2</sup>C compatible serial controller integrated into the MPC8548E. The MPC8548E I<sup>2</sup>C controller is used by the system software to read the contents of the various I<sup>2</sup>C devices located on the MVME4100. The following table contains the I<sup>2</sup>C devices used for the MVME4100 and their assigned device addresses.

Table 4-4 I2C Bus Device Addressing

I2C Bus Address	Device Address A2 A1 A0 (binary)	Size (bytes)	Device Function	Notes
\$98	N/A	N/A	MAX6649 temperature sensor	-
\$A0	000	256 x 8	SO-CDIMM SPD	1
\$A4	010	65,536 x 8	User configuration	2
\$A6	011	65,536 x 8	User configuration	2
\$A8	100	8192 x 8	VPD (on-board system configuration)	2
\$AA	101	8192 x 8	RTM VPD (off-board configuration)	2, 3
\$AC	110	8192 x 8	XMCSpan VPD	-
\$AE	111	-	Reserved	-
\$D0	N/A	N/A	DS1375 real-time clock	-

1. Each SPD defines the physical attributes of each bank or group of banks.
2. This is a dual address serial EEPROM.
3. The device address is user selectable using switches on the RTM. The recommended address setting for the MVME4100 is \$AA.

## 4.6 User Configuration EEPROM

The board provides two 64 KB dual address serial EEPROMs for a total of 128 KB user configuration storage. These EEPROMs are hardwired to have device IDs as shown in [Table 4-4 on page 62](#), and each device ID will not be used for any other function. Refer to the *EEPROM Datasheet* listed in [Appendix B, Related Documentation](#), for additional details.

## 4.7 VPD EEPROM

The MVME4100 board provides an 8 KB dual address serial EEPROM containing Vital Product Data (VPD) configuration information specific to the MVME4100. Typical information that may be present in the EEPROM may include: manufacturer, board revision, build version, date of assembly, memory present, options present, L2 cache information, etc. The VPD EEPROM is hardwired to have a device ID as shown in [Table 4-4 on page 62](#). Refer to the *EEPROM Datasheet* listed in [Appendix B, Related Documentation](#), for additional details.

## 4.8 RTM VPD EEPROM

The MVME4100 RTM provides an 8 KB dual address serial EEPROM containing VPD configuration information specific to the MVME4100 RTM. Typical information that may be present in the EEPROM may include: manufacturer, board revision, build version, date of assembly, options present, etc. The RTM VPD EEPROM device ID is user selectable with the recommended value for MVME4100 as shown in [Table 4-4 on page 62](#). Refer to the *EEPROM Datasheet* listed in [Appendix B, Related Documentation](#), for additional details.

## 4.9 Ethernet PHY Address

The assigned Ethernet PHY addresses on the MPC8548E MII management (MIIM) bus is shown in the following table.

*Table 4-5 PHY Types and MII Management Bus Addresses*

MPC8548E Ethernet Port	Function/Location	PHY Types	PHY MIIM Address [4:0]
TSEC1	Gigabit Ethernet port 1 routed to front panel	BCM5482SH	01
TSEC2	Gigabit Ethernet port 2 routed to front panel	BCM5482SH	02
TSEC3	Gigabit Ethernet port routed to P2	BCM5482SH	03
TSEC4	Gigabit Ethernet port routed to P2	BCM5482SH	04

## 4.10 Flash Memory

The MVME4100 is designed to provide 128 MB of soldered-on NOR flash memory. Two +3.0 V devices are configured to operate in 16-bit mode to form a 32-bit flash bank. This flash bank is also the boot bank and is connected to LBC Chip Select 0 and 1. The NOR flash is accessed via the MPC8548E local bus. The next table shows memory size and device IDs.

*Table 4-6 NOR Flash Memory Configurations*

Device Part Number	Data Bus Width	Bank Size	Device Size	Vendor ID	Device ID
S29GL512P10	32 bits	128 MB	512 megabit	AMD-0001h	7E23h

A hardware Flash Bank write-protect switch is provided on the MVME4100 to enable write protection of the NOR flash. Regardless of the state of the software flash write-protect bit in the NOR Flash Control/Status register, write protection is enabled when this switch is ON. When the switch is OFF, write protection is controlled by the state of the software flash write-protect bits. It is only disabled by clearing this bit in the NOR Flash Control/Status register (refer to section *NOR Flash Control/Status Register on page 31*). Note that the F\_WP\_HW bit reflects the state of the switch and is only software readable whereas the F\_WP\_SW bit supports both read and write operations.

Also included is one bank of NAND flash which is accessed via the MPC8548E local bus. The next table shows the memory sizes and device IDs.

*Table 4-7 NAND Flash Memory Configurations*

Device Part Number	Data Bus Width	Bank Size	Device Size	Vendor ID	Device ID
K9WBG08U1M	8 bits	4 GB	4 GB	Samsung = ECh	D7h

## 4.11 PCI/PCI-X Configuration

The next sections provide information that details the PCI/PCI-X configuration of the various on-board PCI devices.



### 4.11.1 PCI IDSEL and Interrupt Definition

Each PCI device has an associated address line connected via a resistor to its IDSEL pin for Configuration Space accesses. The following table shows the IDSEL assignments for the PCI devices and slots on each of the PCI busses on the board along with the corresponding interrupt assignment to the PIC external interrupt pins. Refer to the MPC8548E datasheet and the PLX PCI6520 data sheet for details on generating configuration cycles on each of the PCI busses.

*Table 4-8 IDSEL and Interrupt Mapping for PCI Devices*

PCI Bus	Device Number Field	AD Line for IDSEL	PCI Device or Slot	Device/Slot INT to MPC8548E IRQ			
				INTA#	INTB#	INTC#	INTD#
PCI1 (8548E)	0b0_0000	internal	MPC8548E	-	-	-	-
	0b0_0001	17	Tsi148 VME	IRQ0	IRQ1	IRQ2	IRQ3
	0b0_0010	18	PCI6520	-	-	-	-
	0b0_0011	19	PCI6520	-	-	-	-
PCI1 (PCI6520)	0b0_0000	20	PMC1 Primary	IRQ4	IRQ5	IRQ6	IRQ07
	0b0_0001	21	PMC1 Secondary	IRQ5	IRQ6	IRQ7	IRQ4
	0b0_0010	22	PMC2 Primary	IRQ6	IRQ7	IRQ4	IRQ5
	0b0_0011	23	PMC2 Secondary	IRQ7	IRQ4	IRQ5	IRQ6
PCI2 (PCI6520)	0b0_0010	20	uPD720101 USB	IRQ4	IRQ5	IRQ6	-

Refer to the MPC8548E reference manual for additional details about the MPC8548E PIC operation.

The following table shows the Vendor ID and the Device ID for each of the planar PCI devices on the MVME4100.

*Table 4-9 Planar PCI Device Identification*

Function	Device	Vendor ID	Device ID
System Controller	MPC8548E	0x1957	0x0012
PCI-X to PCI-X Bridge	PCI6520	0x10B5	0x6520
VME Controller	TSi148	0x10E3	0x0148
USB Controller	μPD720101	0x1033	0x0035

### 4.11.2 PCI Arbitration Assignments

The integrated PCI/X arbiters internal to the PLX PCI6520 provide PCI arbitration for the MVME4100.

The arbitration assignments on the MVME4100 are shown in the next table so that software may set arbiter priority assignments if necessary.

*Table 4-10 PCI Arbitration Assignments*

PCI Bus	Arbitration Assignment	PCI Master(s)
1	8548E REQ/GNT[0]	PCI6520 PCI-X to PCI-X Bridge
1	8548E REQ/GNT[1]	PCI6520 PCI-X to PCI-X Bridge
1	8548E REQ/GNT[2]	Tsi148 VME controller
2	PCI6520 REQ/GNT[0]	PMC site 1 primary master
2	PCI6520 REQ/GNT[1]	PMC site 1 secondary master
2	PCI6520 REQ/GNT[2]	PMC site 2 primary master
2	PCI6520 REQ/GNT[3]	PMC site 2 secondary master
3	PCI6520 REQ/GNT[0]	μPD720101 USB Controller

## 4.12 Other Software Considerations

This section provides information on various board components.

### 4.12.1 MRAM

The MVME4100 provides 512 K bytes of fast non-volatile storage in the form of MRAM (Magnetoresistive Random Access Memory). The MRAM is directly accessible by software in the same manner as the DRAM (that means using processor load and store instructions). The only difference is that the MRAM retains its contents even if the board is power cycled. The MRAM is accessed through the LBC.

The MRAM may be write protected by hardware switches and/or hardware registers. To write the MRAM successfully, software must first ensure that the MRAM's write protection mechanisms have been modified to allow write access to the MRAM.

### 4.12.2 Real Time Clock

The MVME4100 provides a battery backed up DS1375 RTC (Real Time Clock) chip. The RTC chip provides time keeping and alarm interrupts. The RTC chip is an I2C device and is accessed via the I2C bus at address 0xD0.

### 4.12.3 Quad UART

The MVME4100 console RS232 port is driven by the UART built into the MPC8548E chip. In addition, the MVME4100 includes a Quad UART chip which provides the user with four additional 16550 compatible UARTs. These additional UARTs are internally accessed through the LBC bus. The Quad UART chip clock input (which is internally divided to generate the baud rate) is 1.8432 Mhz. These four UARTS physically connect to RS232 DB9 serial ports via the RTM. For programming details refer to the vendor's datasheet referenced in Appendix B.

## 4.12.4 LBC Timing Parameters

The following table defines the timing parameters for the devices on the local bus.

*Table 4-11 LBC Timing Parameters*

	0 NOR Flash	1 NOR Flash	2 NAND Flash	3 MRAM	4 CSR	5 UART	6 Timers
LBCTLD	0	0	0	0	0	0	0
CSNT	1	1	1	1	0	1	0
ACS	0	0	0	0	0	0	0
XACS	0	0	0	0	0	0	0
SCY	4	4	2	1	5	3	5
SETA	0	0	0	0	0	0	0
TRLX	0	0	1	1	0	0	0
EHTR	0	0	0	0	0	0	0
EAD	0	0	0	0	0	0	0

## 4.12.5 USB Oscillator Configuration

Software must configure the USB chip for the correct clock input of 48 MHz.

## 4.13 Clock Distribution

The clock function generates and distributes all of the clocks required for system operation. The PCI-E clocks are generated using a four output differential clock driver. The PCI/PCI-X bus clocks are generated using a MPC9855 clock generator. Additional clocks required by individual devices are generated near the devices using individual oscillators. The following table lists the clocks required on the MVME4100 along with their frequency and source.

*Table 4-12 Clock Assignments*

Device	Clock Signal	Frequency (MHz)	Clock Tree Source	Qty	VIO
MPC8548E	CLK_CPU	66	Oscillator	1	+3.3 V
MPC8548E	CLK125MHZ	125	Oscillator	1	+2.5 V
MPC8548E	CLK_RTC	1	PLD	1	+3.3 V
MPC8548E	CLK_PCI	66/100	MPC9855	1	+3.3 V
PMC1	CLK_PCI1	33/66/100	MPC9855	1	+3.3 V
PMC2	CLK_PCI2	33/66/100	MPC9855	1	+3.3 V
Tsi148	CLK_PCI3	66/100	MPC9855	1	+3.3 V
USB	CLK_PCI4	33	MPC9855	1	+3.3 V
BCM5482S	CLK2_25MHZ	25	Oscillator/Buffer	1	+2.5 V
BCM5482S	CLK3_25MHZ	25	Oscillator/Buffer	1	+2.5 V
Control and Timers PLD	CLK1_25MHZ	25	Oscillator/Buffer	1	+3.3 V
	CLK_LBP	MPX CLK / 8	MPC8548E	1	+3.3 V
QUART	CLK_1.8M	1.8432	Oscillator	1	+3.3 V
USB	CLK_48MHZ	48	Oscillator	1	+3.3 V
RTC	CLK_32K	32.768 KHz	Crystal	1	+3.3 V
ICS9FG104	CLK4_33MHZ	25	Oscillator/Buffer	1	+3.3 V
MPC8548E	CLK_PCIE0	100	ICS9FG104	1	DIFF
XMCspan	CLK_PCIE1	100	ICS9FG104	1	DIFF

### 4.13.1 System Clock

The system clock is driven by an oscillator. The following table defines the clock frequency.

*Table 4-13 Clock Frequencies*

SYSCLK	Core	MXP (Platform)	DDR2	LB
66.67 MHz	1.3 GHz	533 MHz	266 MHz	33 MHz

### 4.13.2 Real Time Clock Input

The RTC clock input is driven by 1 MHz clock generated by the Control and Timers PLD. This provides a fixed clock reference for the MPC8548E PIC timers which software can use as a known timing reference.

### 4.13.3 Local Bus Controller Clock Divisor

The Local Bus Controller (LBC) clock output is connected to the PLD but is not used by the internal logic.

# Programmable Configuration Data

## A.1 Overview

This appendix provides data and specifications pertaining to programmable parts used on the MVME4100. The board is shipped after the programmable parts have been programmed through ATE or boundary scan according to the In-Circuit Test specifications.

*Table A-1 Programmable Devices*

Location	Raw Part #	Manufacturer Part #	Specification Data File	Description
U49	51NL9637X71	AT24C64CN-TH-T	VPD Contents	MVME4100 VPD

## A.2 List of Devices

Several serial EEPROMs with I<sup>2</sup>C interfaces exist on the board to store information needed by software to properly configure the board upon start up. There types of configuration data are:

- Vital Product Data (VPD) pertaining to all board functions - only one on the board
- Vital Product Data (VPD) for the RTM
- Serial Presence Detect (SPD) pertaining to SDRAM characteristics - one per bank
- EEPROMs for configuration data storage

The following table lists the onboard and transition module serial EEPROMs.

*Table A-2 Onboard Serial EEPROMs*

Master	Device Function	Size	Device Address (A2A1A0)	I2C Address	Notes
I2C1	DRAM SPD	256	000b	\$A0	
I2C1	User defined	65536	010b	\$A4	
I2C1	User defined	65536	011b	\$A6	
I2C1	VPD and GEV	8192	100b	\$A8	
I2C1	RTM VPD	8192	101b	\$AA	
I2C1	XMCspan VPD	8192	110b	\$AC	

### A.3 Vital Product Data (VPD) Introduction

The data listed in the following tables are for general reference information. The VPD identifies board information that may be useful during board initialization, configuration and verification. This section includes information on how to perform various tasks to read, modify and correct Vital Product Data, as well as specific format and content information for this product. Information that is contained in the VPD includes:

- Marketing Product Number (MVME4100-0171, MVME4100-0173)
- Factory Assembly Number (0106855E03x, 0106855E04x)
- Serial number of the specific MVME4100
- Processor family number (xxx)
- Hardware clock frequencies (internal, external, fixed, PCI bus)
- Component configuration information (connectors, Ethernet, addresses, flash bank ID, L2 cache ID)
- Security information (VPD type, version and revision data, 32-bit CRC protection)

### A.4 How to Read and Modify VPD Information

`vpdDisplay` may be used to display VPD information.

`vpdEdit` can be used to modify the VPD information.

### A.5 What Happens if VPD Information is Corrupted

If the VPD information becomes corrupted, the following occurs:

- A warning message is displayed in the startup banner.
- The firmware ignores the VPD contents and attempts to acquire information from other sources.
- Some device drivers will not work.
- Some diagnostic tests will fail.
- The board will run much slower than usual.



## A.6 How to Fix Corrupted VPD Information

If you encounter corrupted VPD information, use the following method to fix the corrupted data:

- The firmware is designed to reach the prompt with bad VPD.
- Use the `vpdEdit` command to fix the VPD.

## A.7 What if Your Board Has the Wrong VPD?

If your board has the wrong VPD information, the following occurs:

- No warning message is displayed.
- Incorrect VPD information is seen as correct by the firmware.
- The board may hang during startup (no-start condition).
- The board may be very unstable if it reaches the prompt.
- Device drivers, diagnostic tests and firmware commands may hang or fail in unexpected ways.

## A.8 How to Fix Wrong VPD Problems

If you suspect that your board has problems, as a result of wrong VPD information, select SAFE mode by setting S1:1 ON and reboot the MVME4100. At this point, the firmware will ignore all SROM contents. Use SROM or the IBM command to change the VPD to the correct parameters.

## A.9 Vital Product Data CRC Calculation

When computing the CRC this field (for example, 4 bytes) is set to zero. The CRC only covers the range as specified in the size field (4-bytes). Integer values are formatted/stored in big-endian byte ordering. The VPD CRC generation code is shown in the following example.

```
/*
 * vpdGenerateCRC - generate CRC data for the passed buffer
 * description:
```

```
* This function's purpose is to generate the CRC for the
* passed VPD SROM buffer.
* call:
* argument #1 = buffer pointer
* argument #2 = number of elements
* return:
* CRC data
*/
unsigned int
vpdGenerateCRC(pVpdBuffer, vpdSromSize)
unsigned char *pVpdBuffer;
unsigned int vpdSromSize;
{
    unsigned int crcValue;
    unsigned int crcValueFlipped;
    unsigned char dataByte;
    unsigned int index, dataBitValue, msbDataBitValue;
    crcValue = 0xffffffff;
    for (index = 0; index < vpdSromSize; index++)
    {
        dataByte = *pVpdBuffer++;
        for (dataBitValue = 0; dataBitValue < 8; dataBitValue++)
        {
            msbDataBitValue = (crcValue >> 31) & 1;
```

```
crcValue <<= 1;

if (msbDataBitValue ^ (dataByte & 1))
{
    crcValue ^= 0x04c11db6;
    crcValue |= 1;
}

dataByte >>= 1;
}
}

crcValueFlipped = 0;

for (index = 0; index < 32; index++)
{
    crcValueFlipped <<= 1;
    dataBitValue = crcValue & 1;
    crcValue >>= 1;
    crcValueFlipped += dataBitValue;
}

crcValue = crcValueFlipped ^ 0xffffffff;

return (crcValue);
}
```

## A.10 VPD Contents for MVME4100 Boards

The following tables describe the VPD data to be programmed into U49. [Table A-3](#) contains only the static VPD data and [Table A-4 on page 83](#) contains only the variable VPD data. This information is subject to change (under authority of an engineering change order). If a difference is noted between either of these tables and your board, please contact your support representative to determine which is accurate.

*Table A-3 Static VPD Contents*

Offset (HEX)	Data (HEX)	Field Type	Description
00	45	ASCII	Eye-Catcher ("EMERSON") Note: Lowest CRC byte for the calculation of CRC.
01	4D		
02	45		
03	52		
04	53		
05	4F		
06	4E		
07	20		
08	02	BINARY	Size of VPD area in bytes. The size is viewed as logical; it is not the size of the EEPROM. 512 bytes in this VPD architecture
09	00		
0A	0F	BINARY	VPD Revision Packet
0B	04	BINARY	# of Bytes
0C	00	BINARY	Board Type: Processor Board
0D	03	BINARY	Architecture Revision
0E	00	BINARY	Board Build Revision
0F	00	BINARY	Revision Reason Flags
10	01	BINARY	Product Identifier Packet Refer to Notes 1 and 2.
11	14		
		BINARY	# of bytes

*Table A-3 Static VPD Contents (continued)*

Offset (HEX)	Data (HEX)	Field Type	Description
12	xx	ASCII	Product Identifier. Refer to <a href="#">Table A-4</a> .
13	xx		
14	xx		
15	xx		
16	xx		
17	xx		
18	xx		
19	xx		
1A	xx		
1B	xx		
1C	xx		
1D	xx		
1E	xx		
1F	xx		
20	xx		
21	xx		
22	xx		
23	xx		
24	xx		
25	xx		
26	02	BINARY	Factory Assembly Number. Refer to <a href="#">Notes 1</a> and <a href="#">2</a> .
27	0D	BINARY	# of bytes

Table A-3 Static VPD Contents (continued)

Offset (HEX)	Data (HEX)	Field Type	Description
28	xx	ASCII	Factory Assembly Number. Refer to <a href="#">Table A-4</a> .
29	xx		
2A	xx		
2B	xx		
2C	xx		
2D	xx		
2E	xx		
2F	xx		
30	xx		
31	xx		
32	xx		
33	xx		
34	xx		
35	03		
36	07	BINARY	# of bytes
37	xx	ASCII	Most significant serial number character
38	xx		
39	xx		
3A	xx		
3B	xx		
3C	xx		
3D	xx		
3E	06	BINARY	External Processor Clock Frequency Packet
3F	05	BINARY	# of bytes

*Table A-3 Static VPD Contents (continued)*

Offset (HEX)	Data (HEX)	Field Type	Description
40	03	BINARY	Four bytes containing the SYSCLK frequency. 0x03F940AA = 66.66 MHz
41	F9		
42	40		
43	AA		
44	01	BINARY	First Processor
45	08	BINARY	Ethernet MAC Address Packet
46	07	BINARY	# of bytes
47	xx	BINARY	Six bytes containing the lowest Ethernet address.
48	xx		
49	xx		
4A	xx		
4B	xx		
4C	xx		
4D	00	BINARY	Ethernet Controller 0
4E	08	BINARY	Ethernet MAC Address Packet
4F	07	BINARY	# of bytes
50	xx	BINARY	Six bytes containing the next Ethernet address.
51	xx		
52	xx		
53	xx		
54	xx		
55	xx		
56	01	BINARY	Ethernet Controller 1
57	08	BINARY	Ethernet MAC Address Packet
58	07	BINARY	# of bytes

Table A-3 Static VPD Contents (continued)

Offset (HEX)	Data (HEX)	Field Type	Description
59	xx	BINARY	Six bytes containing the next Ethernet address.
5A	xx		
5B	xx		
5C	xx		
5D	xx		
5E	xx		
5F	02	BINARY	Ethernet Controller 2
60	08	BINARY	Ethernet MAC Address Packet
61	07	BINARY	# of bytes
62	xx	BINARY	Six bytes containing the highest Ethernet address.
63	xx		
64	xx		
65	xx		
66	xx		
67	xx		
68	03	BINARY	Ethernet Controller 3
69	09	BINARY	Processor Identifier Packet
6A	05	BINARY	# of bytes
6B	xx	ASCII	Processor type Refer to <a href="#">Table A-4</a> .
6C	xx		
6D	xx		
6E	xx		
6F	xx		



Table A-3 Static VPD Contents (continued)

Offset (HEX)	Data (HEX)	Field Type	Description
70	0A	BINARY	<p>EPROM CRC</p> <p>When computing the CRC this field (4 bytes) is set to zero. This CRC only covers the range as Integer (4-byte). Refer to <i>Vital Product Data CRC Calculation on page 73</i>.</p> <p>Note:                      Lower CRC byte for the calculation of CRC = 0x00                      Upper CRC byte for the calculation of CRC = 0x1F</p>
71	04	BINARY	# of bytes
72	xx	BINARY	** CRC to be filled in
73	xx		
74	xx		
75	xx		
76	0B	BINARY	Bank 1 Flash Memory Configuration Packet
77	0C	BINARY	# of bytes
78	00	BINARY	Vendor Identifier
79	01		
7A	7E	BINARY	Device Identifier
7B	23		
7C	10	BINARY	Single device width in bits
7D	02	BINARY	Number of devices or sockets present
7E	01	BINARY	Number of interleave columns
7F	20	BINARY	Column width in bits
80	20	BINARY	Minimum write/erase data width in bits
81	01	BINARY	Flash bank number
82	6E	BINARY	Flash access speed in nanoseconds: 0x6E = 110 ns
83	09	BINARY	Total bank size [(1<<n) * 256K bytes]: 0x09 = 128 MB
84	0B	BINARY	Bank 2 Flash Memory Configuration Packet
85	0C	BINARY	# of bytes

Table A-3 Static VPD Contents (continued)

Offset (HEX)	Data (HEX)	Field Type	Description
86	00	BINARY	Vendor Identifier
87	EC		
88	D5	BINARY	Device Identifier
89	51		
8A	08	BINARY	Single device width in bits
8B	01	BINARY	Number of devices or sockets present
8C	01	BINARY	Number of interleave columns
8D	08	BINARY	Column width in bits
8E	08	BINARY	Minimum write/erase data width in bits
8F	02	BINARY	Flash bank number
90	2D	BINARY	Flash access speed in nanoseconds: 0x2D = 45 ns
91	xx	BINARY	Total bank size [(1<<n)* 256K bytes]: 0x0E = 4 GB, 0x0F = 8 GB. Refer to <a href="#">Table A-4</a> .
92	FF	BINARY	Not Used
:	:	:	:
1FF	FF	BINARY	Not Used

### Notes

1. This data is not static. Each board must be assigned with an entity unique to the board assembly number.
2. The method used to program the Product Identifier, Factory Assembly Number, and Serial Number packets requires that these packets be located in absolute fixed locations. For this reason, these packets shall have fixed sizes and shall immediately follow the header.
3. This data is not static. Each board's Serial Number packet must be unique. The board's serial number is obtained from the onboard serial number label.

The "xx" in [Table A-4](#) at address 0x32 represents the assembly revision letter (A=41, B=42, etc.).

*Table A-4 Variable VPD Contents*

Offset (Hex)	MVME4100-0171	MVME4100-0173
	<b>0106855E03x</b>	<b>0106855E04x</b>
-	-	-
12	4D	4D
13	56	56
14	4D	4D
15	45	45
16	34	34
17	31	31
18	30	30
19	30	30
1A	2D	2D
1B	31	31
1C	37	37
1D	31	33
1E	20	20
1F	20	20
20	20	20
21	20	20
22	20	20
23	20	20
24	20	20
25	20	20
-	-	-
28	30	30
29	31	31

Table A-4 Variable VPD Contents (continued)

Offset (Hex)	MVME4100-0171	MVME4100-0173
	0106855E03x	0106855E04x
2A	30	30
2B	36	36
2C	38	38
2D	35	35
2E	35	35
2F	45	45
30	30	30
31	33	34
32	XX	XX
33	00	00
34	00	00
-	-	-
40	03	03
41	F9	F9
42	40	40
43	AA	AA
-	-	-
91	0F	0F

# Related Documentation

## B.1 Emerson Network Power - Embedded Computing Documents

The Emerson Network Power - Embedded Computing publications listed below are referenced in this manual. You can obtain electronic copies of Emerson Network Power - Embedded Computing publications by contacting your local Emerson sales office. For documentation of final released (GA) products, you can also visit the following website:

[www.emersonnetworkpower.com/embeddedcomputing](http://www.emersonnetworkpower.com/embeddedcomputing) > Solution Services > Technical Documentation Search. This site provides the most up-to-date copies of Emerson Network Power - Embedded Computing product documentation.

*Table B-1 Emerson Network Power - Embedded Computing Publications*

Document Title	Publication Number
MVME4100 Single Board Computer Installation and Use	6806800H18
MOTLoad Firmware Package User's Manual	6806800C24

## B.2 Manufacturers' Documents

For additional information, refer to the following table for manufacturers' data sheets or user's manuals. As an additional help, a source for the listed document is provided. Please note that, while these sources have been verified, the information is subject to change without notice.

*Table B-2 Manufacturer's Publications*

Document Title and Source	Publication Number
<i>Spanion</i>	
S29GL-P MirrorBit™ Flash Family S29GL01GP, S29GL512P, S29GL256P, S29GL128P 1 Gigabit, 512 Megabit, 256 Megabit and 128 Megabit 3.0 Volt-only Page Mode Flash Memory featuring 90 nm MirrorBit Process Technology 27631	Revision A Amendment 11 June 11, 2008

Table B-2 Manufacturer's Publications (continued)

Document Title and Source	Publication Number
<b>Atmel Corporation</b>	
2-Wire Serial EEPROM 32K (4096 x 8), 64K (8192 x 8) AT24C32C, AT24C64C	5174B-SEEPR-12/06
2-Wire Serial EEPROM 512K (65,536 x 8) AT24C512	Rev. 1116K-SEEPR-1/04
<b>NEC Corporation</b>	
<b>Data Sheet</b> μPD720101 USB2.0 Host Controller	S16265EJ3V0DS00 April 2003
<b>Freescale Corporation</b>	
MPC8548E Integrated Host Processor Reference Manual	MPC8548ERM Rev. 2 02/2007
MPC8548E Errata	
MPC8548E Integrated Processor Hardware Specifications	MPC8548EEC Rev. 1 10/2007
Freescale MR2A16A 512 MB MRAM	MR2A16A Rev. 5 9/2007
<b>Texas Instruments</b>	
<b>Data Sheet</b> SN74VMEH22501 8-bit Universal Bus Transceiver and Two 1-bit Bus Transceivers with Split LVTTTL Port, Feedback Path, and 3-state Outputs	SCES357E Revised March 2004
<b>Exar</b>	
ST16C554/554D, ST68C554 Quad UART with 16-Byte FIFO's	Version 4.0.1 June 2006

Table B-2 Manufacturer's Publications (continued)

Document Title and Source	Publication Number
<b>Maxim Integrated Products</b>	
DS1375 Serial Real-Time Clock	REV: 121203
MAX3221E/MAX3223E/MAX3243E $\pm 15$ kV ESD-Protected, 1 $\mu$ A, 3.0V to 5.5V, 250kbps, RS-232 Transceivers with AutoShutdown	19-1283 Rev 5 10/03
MAX811/MAX812 4-Pin $\mu$ P Voltage Monitors With Manual Reset Input	19-0411 Rev 3 3/99
MAX6649 Digital Temperature Sensor	19-2450 Rev 3 05/07
<b>Tundra Semiconductor Corporation</b>	
Tsi148 PCI/X-to-VME Bus Bridge User Manual	FN 80A3020 MA001_08

*Table B-2 Manufacturer's Publications (continued)*

Document Title and Source	Publication Number
<b>Broadcom Corporation</b>	
BCM5482S 10/100/1000BASE-T Gigabit Ethernet Transceiver	5482S-DS06-R 2/15/07
<b>PLX Technology</b>	
PCI6520 PCI-X to PCI-X Bridge Databook	Version 2.0

## B.3 Related Specifications

For additional information, refer to the following table for related specifications. As an additional help, a source for the listed document is provided. Please note that, while these sources have been verified, the information is subject to change without notice.

*Table B-3 Related Specifications*

Organization and Standard	Document Title
<b>VITA Standards Organization</b>	
VME64	ANSI/VITA 1-1994
VME64 Extensions	ANSI/VITA 1.1-1997
2eSST Source Synchronous Transfer	ANSI/VITA 1.5-2003
Increased Current Level for 96 pin & 160 pin DIN/IEC Connector Standard	ANSI/VITA 1.7
Processor PMC	ANSI/VITA 32-2003
PCI-X on PMC	ANSI/VITA 39-2003
PMC I/O Module (PIM) Draft Standard	VITA 36 Draft Rev 0.1 July 19, 1999
<b>Universal Serial Bus</b>	
Universal Serial Bus Specification	Revision 2.0 April 27, 2000



Table B-3 Related Specifications (continued)

Organization and Standard	Document Title
<b>PCI Special Interest Group</b>	
PCI Local Bus Specification, Revision 2.2	PCI Rev 2.2 December 18, 1998
PCI-X Electrical and Mechanical Addendum to the PCI Local Bus Specification, Revision 2.0a	PCI-X EM 2.0a August 22, 2003
PCI-X Protocol Addendum to the PCI Local Bus Specification, Revision 2.0a	PCI-X PT 2.0a July 22, 2003
<b>Institute for Electrical and Electronics Engineers, Inc.</b>	
IEEE Standard for a Common Mezzanine Card Family: CMC Family	IEEE Std 1386 - 2001
IEEE Standard Physical and Environmental Layer for PCI Mezzanine Cards (PMC)	IEEE Std 1386.1 - 2001

# Related Documentation



## HOW TO REACH LITERATURE AND TECHNICAL SUPPORT:

Tempe, Arizona, USA  
1 800 759 1107  
1 602 438 5720

Munich, Germany  
+49 89 9608 0

For literature, training, and technical assistance and support programs, visit  
[www.emersonnetworkpowerembeddedcomputing.com](http://www.emersonnetworkpowerembeddedcomputing.com)

### Emerson Network Power.

The global leader in enabling Business-Critical Continuity™

[www.emersonnetworkpowerembeddedcomputing.com](http://www.emersonnetworkpowerembeddedcomputing.com)

- |                    |                                |                             |                             |
|--------------------|--------------------------------|-----------------------------|-----------------------------|
| ■ AC Power Systems | ■ <b>Embedded Computing</b>    | ■ Outside Plant             | ■ Services                  |
| ■ Connectivity     | ■ Embedded Power               | ■ Power Switching & Control | ■ Site Monitoring           |
| ■ DC Power Systems | ■ Integrated Cabinet Solutions | ■ Precision Cooling         | ■ Surge & Signal Protection |

Emerson, Business-Critical Continuity, Emerson Network Power and the Emerson Network Power logo are trademarks and service marks of Emerson Electric Co. All other product or service names are the property of their respective owners.

© 2009 Emerson Electric Co.